

## CHANGE ORDER

**Project Number** 62200529

**Project Title** Airfield & Landside Design - 250/300 NW  
Richards Road Electrical Upgrade (Bid No. 2)

Change Order No: 5-R1 Date of Issuance: November 3, 2022

Ordinance No: 210710 Ordinance Effective Date: October 3, 2021  
Contract Notice To Proceed Date: October 1, 2021

To CONTRACTOR: **CITADEL ELECTRIC GROUP, INC**

The Contract is changed as follows: Provide a new S&C Switch w/Micro switching to feed Hangars 2 & 3 transformers. Current lead time for this equipment is 42 to 44 weeks, contract time will be increased at a later date. Federal Supplementary Provisions are also being added to the contract.

This Change Order constitutes compensation in full on behalf of the Contractor and its subcontractors and suppliers for all costs, including impact costs and extended general conditions, and markups directly and indirectly attributable to the Work changes ordered herein, for all delays related thereto and for performance of the changes within the time stated. Contractor hereby releases all claims for delay, interruption, extended general conditions, impact and cumulative impact claims for this Work.

See Attached Document(s).

Attachment A - Citadel Proposal - Add S&C Switch w/Micro Switching (19 pages)

Attachment B - Federal Supplementary Provisions (5 pages)

**Not valid until signed by the Director of Finance.**

The original Contract Price was	<u>\$1,214,435.00</u>
Net change by previously authorized Change Orders	<u>\$14,320.00</u>
The Contract Price prior to this Change Order was	<u>\$1,228,755.00</u>
The Contract Price will be ( <input checked="" type="checkbox"/> increased by) ( <input type="checkbox"/> decreased by) ( <input type="checkbox"/> unchanged)	<u>\$308,174.00</u>
The new Contract Price including this Change Order will be	<u>\$1,536,929.00</u>

The Contract Time will be ( <input type="checkbox"/> increased by) ( <input type="checkbox"/> decreased by) ( <input checked="" type="checkbox"/> unchanged)	<u>303 calendar days</u>
The date of Substantial Completion as of the date of this Change Order therefore is	<u>July 30, 2022</u>
The date of Final Completion as of the date of this Change Order therefore is	<u>July 30, 2022</u>

Project No. & Title 62200529 Airfield & Landside Design - 250/300 NW Richards Road Electrical Upgrade (Bid No. 2)  
 Change Order No. 5-R1

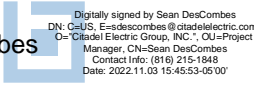
<b>DESIGN PROFESSIONAL:</b> <b>WSP USA</b> <b>300 Wyandotte Street, Suite 200</b> <b>Kansas City, MO 64105</b>	<b>By: Dale E. Mueller, P.E.</b>  <b>Title: Senior Project Manager</b>	<b>Date:</b>  <b>11/3/22</b>
<b>CONTRACTOR:</b> <b>Citadel Electric Group, Inc</b> <b>31710 E Colbern Road</b> <b>Oak Grove, MO 64075</b>	<b>By: Sean DesCombes</b>  <b>Sean DesCombes</b> <b>Title: Project Manager</b>	<b>Date:</b>  <b>11/3/2022</b>
<b>CITY: Kansas City, Missouri</b> <b>Kansas City Aviation Department</b> <b>601 Brasilia Avenue</b> <b>Kansas City, MO 64153</b>	<b>By: Patrick Klein</b>  <b>Title: Director of Aviation</b>	<b>Date:</b>

Approved as to form: \_\_\_\_\_  
 Assistant City Attorney

I certify there is a balance otherwise unencumbered to the credit of the appropriation to which the above amount is chargeable, and a cash balance otherwise unencumbered in the treasury to the credit of the fund from which payment is to be made, each sufficient to meet the above obligation.

\_\_\_\_\_  
 Director of Finance \_\_\_\_\_  
 Date

Distribution:       CITY                       CONTRACTOR                       DESIGN PROFESSIONAL

**REMINDER:** CONTRACTOR is responsible for considering the effect this Change Order may have on its ability to meet or exceed the D/M/WBE participation amounts in its Contractor Utilization Plan (CUP) as amended by any previously approved Request for Modification/Substitution. If CONTRACTOR will not be able to achieve the approved participation amounts in performing the work included within this Change Order, or if CONTRACTOR needs to retain the services of additional D/M/WBEs not previously listed in its CUP, CONTRACTOR is advised to submit a Request for Modification/Substitution.

**CITADEL**  
**ELECTRIC GROUP, INC.**  
 31710 E. Colbern Rd. \* Oak Grove, MO 64075

**SCOPE / PROPOSAL**

October 31, 2022

Attention: **Sam Stallbaumer**  
**WSP**  
**300 Wyandotte Ave, Suite 200**  
**Kansas City, MO 64105**

Regarding: MKC Airfield and Landside Design – Electrical Scope and Proposal  
 CCN#06 Rev1 – Added S&C Switch w/Micro Switching

Mr. Stallbaumer,

This letter outlines the scope of our proposal for the above referenced project.

**Proposal includes but not limited to the following:**

1. Citadel Electric shall provide all Labor, Materials, Supervision, Equipment and Tools as necessary to accomplish the **Scope of Work** in accordance with details as referenced in the following inclusions and referenced/clarified in the exclusions below.
- Bid 0001 – Intercept existing ductbank run feeding Hangers 2 & 3's transformers and:
- Supply and Install (1) new S&C PME-9 Switch w/Micro switching per the following drawing. Includes intercepting existing pathways at the new switch location and providing new wire and terminations at the new manhole just installed and existing transformers. (it is assumed that the new manhole in the parking lot feeds the hanger 2 & 3 transformers).
  - We are planning to utilize the existing wire and terminations conditions at the transformers where we are not pulling new wire.
  - Quote price for the S&C switch is 30 days from 9/27/2022 as stated on the S&C quote.
  - Temp power provided by generator for both Xfmrs. This includes (2) generators. Hanger 2&3 will be without power for an estimated 2-3 hours each at different times to allow temp power to be hooked up and then 2-3 hours each to put back on new power.
  - Current lead time at time of quote is 42-44 weeks. This is subject to change.
  - Temp generator fuel costs are figured at current rate of \$6.16 per gallon. At time of use this will be recalculated to reflect real time costs and a add/deductive change order can be given to adjust for these costs.
  - MBE/WBE participation is included.

**Proposal excludes the following:**

1. Any additional costs associated with Engineering or Design.
2. Any other work not clarified in the original scope change request.
3. Any overtime or extended time associated with an occupied building.
4. Any replacements parts on existing equipment.

**For the Base Bid work as set forth above, we are quoting the following:**

<b>ITEM</b>	<b>Description</b>	<b>Amount</b>
0001	Hanger 2 & 3 Gear Changes .....	<b>\$ 308,174.00</b>

**Grand total: \$ 308,174.00**

If you have any questions and/or comments pertaining to this scope proposal, then please feel free to contact me.

Our quotation is valid for a period of 90 days from this date unless an agreement is made between all parties.

Respectfully,

Sean DesCombes  
 Project Manager  
 Citadel Electric Group, Inc.

# COST PROPOSAL



Client Address:

**MKC**  
150 Richards Rd  
Kansas City, MO 64116

**CCN #** 6 - Hanger 2&3 Gear Rev1  
**Ref #1**  
**Date:** 10/31/2022  
**Project Name:** MKC - Airfield & Landside Design  
**Project Number:** 62200529  
**Contract #:**  
**Page Number:** 1  
**Change Order #:**  
**Change Order Date:**

## Work Description

Provide a new S&C Switch w/Mirco switching to feed hangers 2 & 3 transformers.

## Itemized Breakdown

Description	Qty	Total Mat.	Total Hrs.
13200 - SECTIONAL SWITCHGEAR	1	0.00	20.00
3" ELBOW 90 DEG - RMC - GALV	4	270.39	10.00
3" LOCKNUT - STEEL	8	14.52	4.00
3" CONDUIT - PVC40	160	1,050.96	20.00
3" COUPLING - PVC	8	17.68	0.50
3" ADAPTER FEM - PVC	8	23.99	5.00
# 2/1C 15KV SHLD 100% - AL	2,080	9,984.00	104.00
CONDUIT MEASURING TAPE	160	6.80	1.60
# 2 15KV HV TERMINATION	18	9,000.00	54.00
#1/0 TO #4/0 3-WAY SPLCE	6	4,500.00	48.00
# 2 WIRE POWER TERM	16	800.00	17.60
SWITCHGEAR EXCAVATION	1	0.00	40.00
SWITCHGEAR PAD	1	2,500.00	16.01
PARKING LOT REPAIR	1	15,000.00	24.00
<b>Totals</b>	<b>2,472</b>	<b>43,168.34</b>	<b>364.70</b>

## Summary

General Materials		43,168.34
<b>Total Material</b>		<b>43,168.34</b>
GENERAL FOREMAN	(364.70 Hrs @ \$86.05)	31,382.44
PROJECT MANAGEMENT (@5% min 2HRS)	(40.00 Hrs @ \$110.00)	4,400.00
MBE/WBE OFFICE MANAGEMENT	(40.00 Hrs @ \$65.00)	2,600.00
SAFETY	(364.70 @ 0.00 @ \$0.03 + 0.000 % + 0.000 % + 0.000 %)	10.94
SMALL TOOLS	(31,382.44 @ 0.00 @ \$0.02 + 0.000 % + 0.000 % + 0.000 %)	627.65
CLEAN UP	(364.70 @ 0.00 @ \$0.01 + 0.000 % + 0.000 % + 0.000 %)	3.65
TRANSPORTATION	(364.70 @ 0.00 @ \$5.00 + 0.000 % + 0.000 % + 0.000 %)	1,823.50
MOBILIZATION	(1.00 @ 0.00 @ \$2,500.00 + 0.000 % + 0.000 % + 0.000 %)	2,500.00
GENERATOR RENTAL	(1.00 @ 1.00 @ \$21,780.00 + 0.000 % + 0.000 % + 0.000 %)	21,780.00
DIESEL FUEL	(4,368.00 @ 1.00 @ \$6.16 + 0.000 % + 0.000 % + 0.000 %)	26,906.88
<b>Subtotal</b>		<b>135,203.40</b>
Markup	(@ 10.00 %)	13,520.34

**ORIGINAL**

# COST PROPOSAL

CCN # 6 - Hanger 2&3 Gear Rev1  
Date: 10/31/2022  
Project Name: MKC - Airfield & Landside Design  
Project Number: 62200529  
Contract #:  
Page Number: 2  
Change Order #:  
Change Order Date:

## Summary (Cont'd)

<b>Subtotal</b>		<b>148,723.74</b>
HAGGARD CRANE RENTAL	(\$2,000.00 + 0.000 % + 0.000 % + 0.000 %)	2,000.00
PRIVATE LOCATES	(\$1,000.00 + 0.000 % + 0.000 % + 0.000 %)	1,000.00
E&S EXCAVATING	(\$19,000.00 + 0.000 % + 0.000 % + 5.000 %)	19,950.00
WITEC ELECTRIC	(\$130,000.00 + 0.000 % + 0.000 % + 5.000 %)	136,500.00
<b>Subtotal</b>		<b>308,173.74</b>
Final Adjustment		0.26
<b>Final Amount</b>		<b>\$308,174.00</b>

## CONTRACTOR CERTIFICATION

Name:	_____
Date:	_____
Signature:	_____

I hereby certify that this quotation is complete and accurate based on the information provided.

## CLIENT ACCEPTANCE

CCN #	6 - Hanger 2&3 Gear Rev1
Final Amount:	\$308,174.00
Name:	_____
Date:	_____
Signature:	_____
Change Order #:	_____

I hereby accept this quotation and authorize the contractor to complete the above described work.

## Work Description

ORIGINAL



# New Condition

Existing HV vault in parking lot

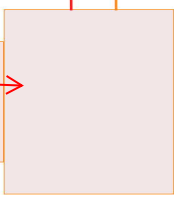

Source A  
Source B

New cabling

New PME-9 Switch w/Micro switching

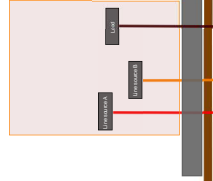

existing to remain

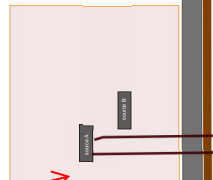

End of Line

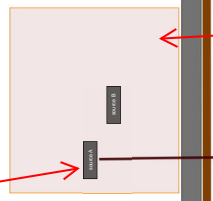

Existing to remain  
500 kva 13200/480y.277v - xfmr



Existing to remain  
500 kva 13200/208y.120v  
- Loop feed to other xfmr



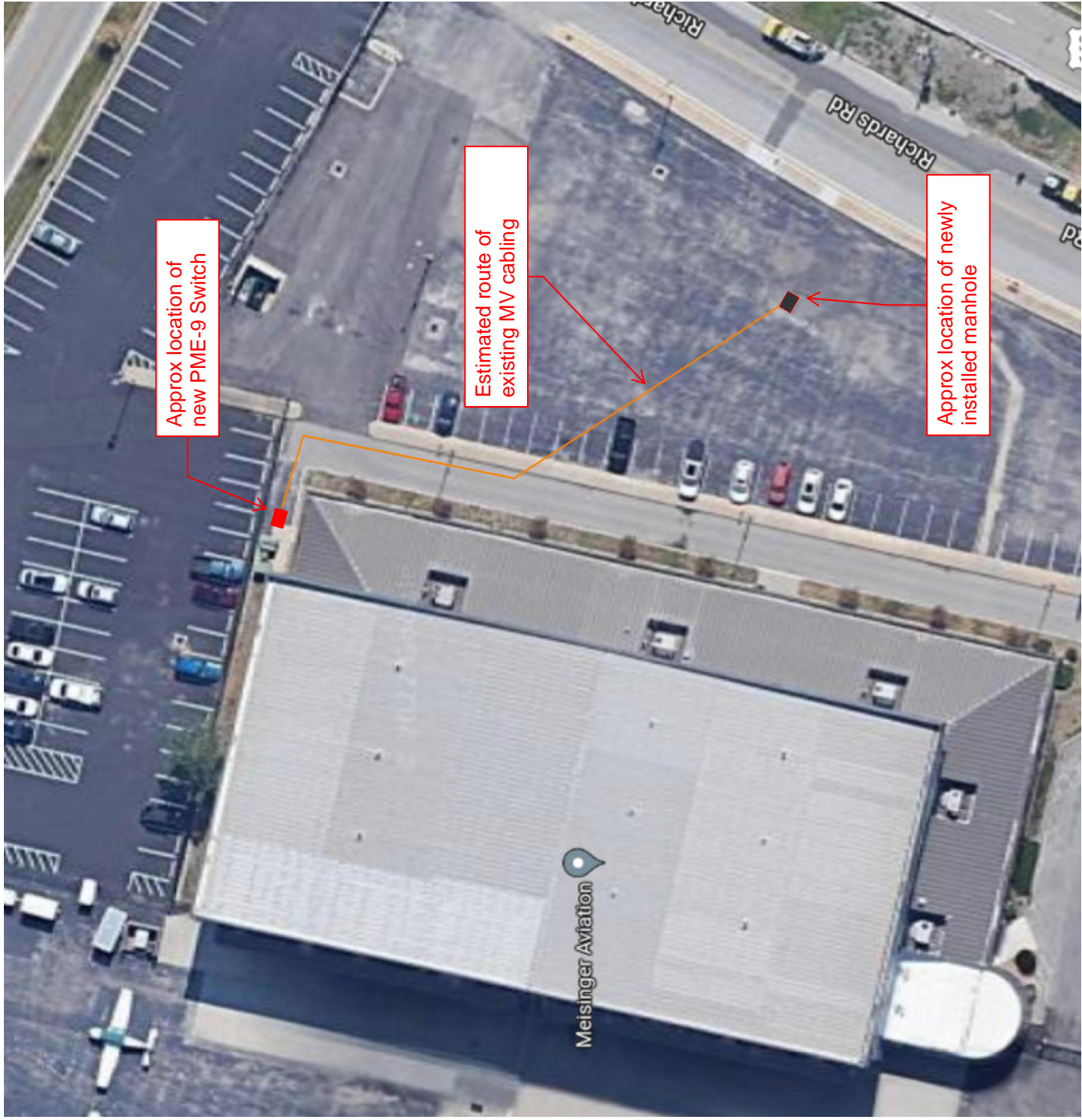

Approx. location of new PME-9 Switch

Estimated route of existing MV cabling

Approx. location of newly installed manhole

Meisinger Aviation

Richards Rd

Richards Rd

Pa



**CITADEL**  
**ELECTRIC GROUP, INC.**  
31710 E. Colbern Rd. \* Oak Grove, MO 64075

Whatever It Takes Electrical Contractor, LLC, DBA WITEC  
9709 E 56<sup>th</sup> St.  
Raytown, MO. 64133

10/31/2022

Attn: John Rolls

Regarding: MKC Airfield and Landside Design  
Kansas City, Missouri  
KCAD Project No. 62200529

Subject: Notice to Award Subcontract

John Rolls,

Consider this letter as an intent for Citadel to award a subcontract to WITEC if we are awarded the contract change order associated with Citadel's scope/proposal CCN#06 Rev1 Added S&C Switch w/Micro Switching.

Estimated subcontract value: \$130,000.00

Respectfully,

Sean DesCombes  
Project Manager  
Citadel Electric Group



Project: Provide and install new S&C switch per attached quote supplied by Citadel

Date: 10-31-2022

All work is quoted on a straight time basis. Materials pricing is subject to adjustment after 30 DAYS, without contract.

**Includes:**

100% MBE/DBE

Provide and install new S&C switch per attached quote supplied by Citadel

Receive switch on the jobsite for installation on base supplied by Citadel

**Excludes:**

Explosion proof devices, lighting, seal offs or explosion proof conduit fittings/boxes

Scaffolding, dumpsters, temporary power/lighting, task lighting for worksite, traffic control or on-site office

Electrical engineering, stamped drawings, independent/3<sup>rd</sup> party testing or design/build services

Bid bonds, performance and payment bonds or material/use/taxes

Overtime/weekend, holiday work or full-time on-site electrician

Providing anything not listed in S&C switch BOM per attached quote supplied by Citadel

Storage on new switch at off jobsite location

Anything not specifically mentioned in this proposal

Basebid - \$130,00.00

Thanks again for your interest in WITEC. Please direct all future written correspondence to myself at the address above. I can be reached during normal business hours at 816-743-0770 or email at Alan@witecinc.com

This proposal does not constitute automatic acceptance of any other terms and conditions unless agreed to in writing.

This proposal is void if not accepted in writing within 30 days after the date of this document.

By: Alan Neal (Estimator)



S&C Electric Company  
6601 North Ridge Boulevard  
Chicago, Illinois 60626-3997  
U.S. Toll-Free and Emergency Number:  
+1 (888) 762-1100  
For Emergencies Outside the U.S. call:  
+1 (773) 338-1000

**Quote #:** Q-61640-2  
**Date:** 27-SEP-2022  
**Expires On:** 12-MAY-2022  
**Related Case:** 00373750

## Quotation

Territory Manager:  
Charles Spann  
charles.spann@sandc.com

Butler Supply  
Lee's Summit, MO

WE ARE PLEASED TO SUBMIT THE FOLLOWING QUOTATION SUBJECT TO THE TERMS AND CONDITIONS AS LISTED BELOW

QUOTE PREPARED BY	PHONE	EMAIL	DELIVERY METHOD	PAYMENT METHOD
Tibebu Zergaw		tibebu.zergaw@sandc.com	Ground	Net 30 Days

### PME-9

LINE	QTY	CATALOG NUMBER	DESCRIPTION	UNIT PRICE	EXTENDED
01	1	66252R1-Y2Y4Y6Y8-E100	66252R1-Y2Y4Y6Y8-E100--14.4KV OLIVE GREEN SOURCE-TRANSFER PME PAD-MOUNTED GEAR -- OUTDOOR PRIMARY DISTRIBUTION -- POWER-OPERATED TYPE -- MODEL PME-9 -- WITH MICRO-AT CONTROL INCLUDES CUSTOMER PROPERTY  SOURCE-TRANSFER PME PAD-MOUNTED GEAR	USD 103,876.34	USD 103,876.34
02	6	3093-MEG	S&C POWER FUSE - TYPE SME-20 INDOOR DISTRIBUTION - FUSE UNIT END FITTINGS (INCLUDING SILENCER) FOR USE WITH SMU-20	USD 424.73	USD 2,548.38
03	6	612XXX -MEG	612XXX -MEG --KILOVOLTS: 14.4 SMU-20 POWER FUSE UNIT RATING TBD	USD 173.12	USD 1,038.72
<b>Group1 TOTAL:</b>					USD 107,463.44

Total w/wifi adapter: \$ 107,936.56

### PME-6

LINE	QTY	CATALOG NUMBER	DESCRIPTION	UNIT PRICE	EXTENDED
04	1	66222R1-Y2Y4Y5Y6Y8-E100	66222R1-Y2Y4Y5Y6Y8-E100--VOLTS: 14.4 COLOR: OLIVE GREEN --SOURCE-TRANSFER PME PAD-MOUNTED GEAR -- OUTDOOR PRIMARY DISTRIBUTION -- POWER-OPERATED TYPE -- MODEL PME-9 -- WITH MICRO-AT CONTROL INCLUDES CUSTOMER PROPERTY  SOURCE-TRANSFER PME PAD-MOUNTED GEAR	USD 99,993.00	USD 99,993.00

05	3	3093-MEG	S&C POWER FUSE - TYPE SME-20 INDOOR DISTRIBUTION - FUSE UNIT END FITTINGS (INCLUDING SILENCER) FOR USE WITH SMU-20	USD 446.23	USD 1,338.69
06	3	612100 -MEG	612XXX -MEG --KILOVOLTS: 14.4 SMU-20 POWER FUSE UNIT RATING TBD	USD 173.12	USD 519.36
<b>Group2 TOTAL:</b>					USD 101,851.05

Wi-Fi KIT

LINE	QTY	CATALOG NUMBER	DESCRIPTION	UNIT PRICE	EXTENDED
07	1	TA-3401	MICRO-AT WI-FI ADAPTER KIT	USD 473.12	USD 473.12
<b>Group3 TOTAL:</b>					USD 473.12

**Safety has always been S&C's number one priority. Though S&C is still committed to serving our customers while maintaining appropriate health precautions, the impacts of COVID-19 cannot be reasonably determined at this time. This quote does not account for any potential adverse impacts COVID-19 may have on S&C's performance or obligations herein. In the event of any delays or adverse impacts, S&C reserves the right for an equitable adjustment of the delivery schedule and prices herein to offset the effects of COVID-19 delays, without fault or penalty of any kind. By accepting this quote or issuing a purchase order for the quoted products and/or services, you agree to and accept these terms.**

**Ship Schedule**

Lead-time for the quoted material is approximately 42 to 44 weeks after receipt of your formal purchase order. All shipping estimates are subject to prior sales of material and/or manufacturing capacity.

**Terms and Conditions of Sale**

This proposal is in accordance with S&C general terms and conditions of sales (**S&C Price Sheets 150, 155, 156, 171,172, 181, & 183**); those applicable to this proposal are provided in the Appendix section. Prices quoted exclude any manufacturer's sales, use or other excise taxes or duties. Any such taxes which Seller is required to pay or collect will be invoiced to Buyer.

Links to the aforementioned Price Sheets may be found on our public website ([click here for S&C Price Sheets](#))

**Terms of Payment:** Net 30 Days

**Terms of Delivery:** F.O.B. Factory: Prices are F.O.B. common carrier shipment point, with seller's selection of transportation prepaid to common carrier delivery point nearest first destination on orders with net invoice value of \$5,000.00 or more. For orders with less than \$5,000.00 net value, prices are F.O.B. Common carrier shipment point, freight collect or prepaid and added to the invoice.

**Purchase Order:** Please send a purchase order to:

S&C Electric Company  
C/O S&C Electric Company  
Tibebu Zergaw

This quotation is valid for thirty (30) days from date of creation.



S&C Micro-AT Source-Transfer Controls are designed for use in S&C Metal-Enclosed Switchgear and Source-Transfer Pad-Mounted Gear, in conjunction with power-operated S&C Mini-Rupter® Switches or S&C Alduti-Rupter® Switches, to provide automatic source transfer for common-bus or split-bus primary selective systems rated through 34.5 kV.

When so applied, Micro-AT Source-Transfer Controls ensure a high degree of critical-load continuity by minimizing interruptions resulting from the loss of one source. Excluding the intentional time delay to coordinate with upstream protective devices and/or transition dwell time, transfer is achieved in 10 cycles when the control is combined with power-operated Mini-Rupter Switches or 3 seconds when the control is combined with power-operated Alduti-Rupter Switches.

- An adjustable time delay to allow motor residual voltage—the voltage appearing at the terminals of a connected motor when the source is interrupted—to drop sufficiently before the service is restored.

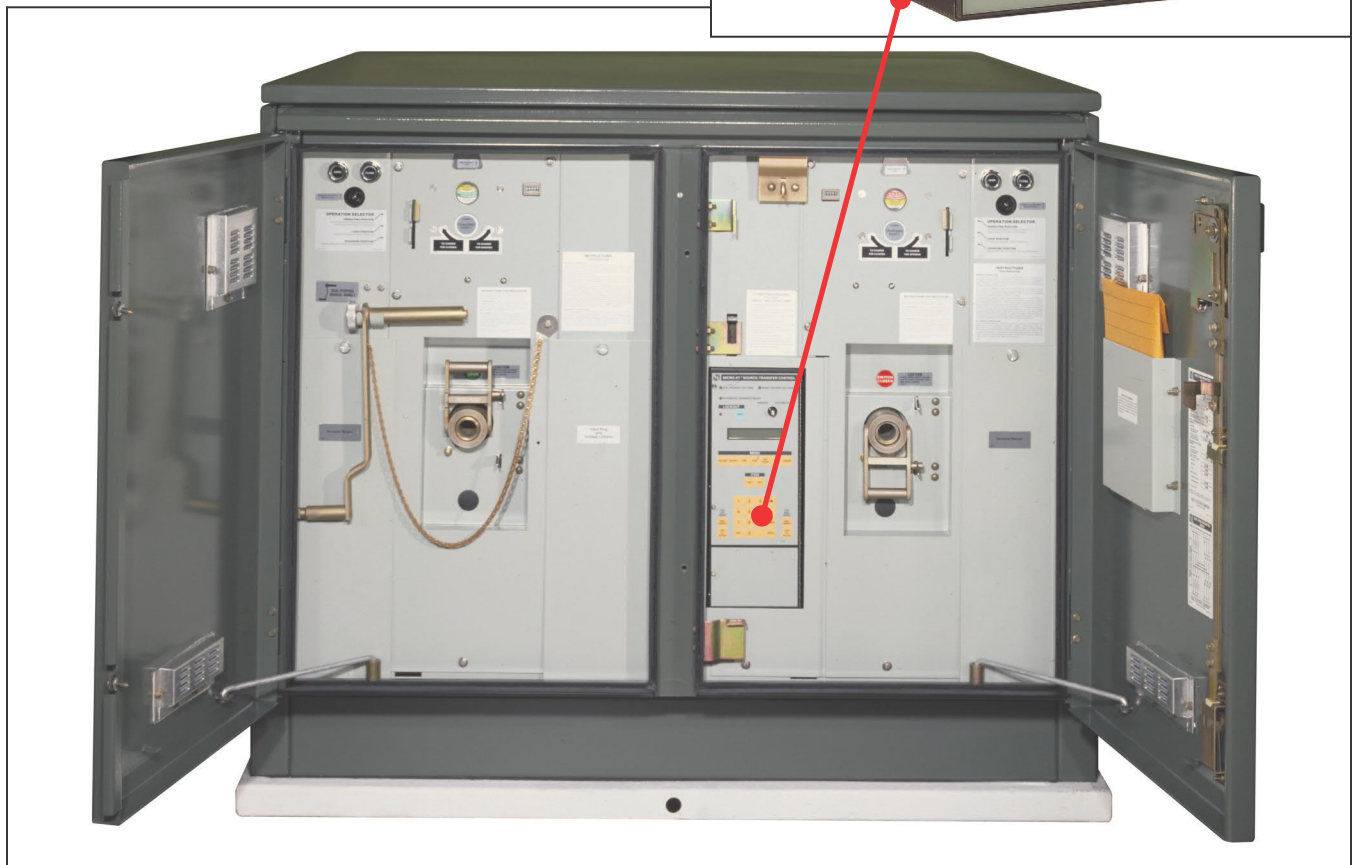
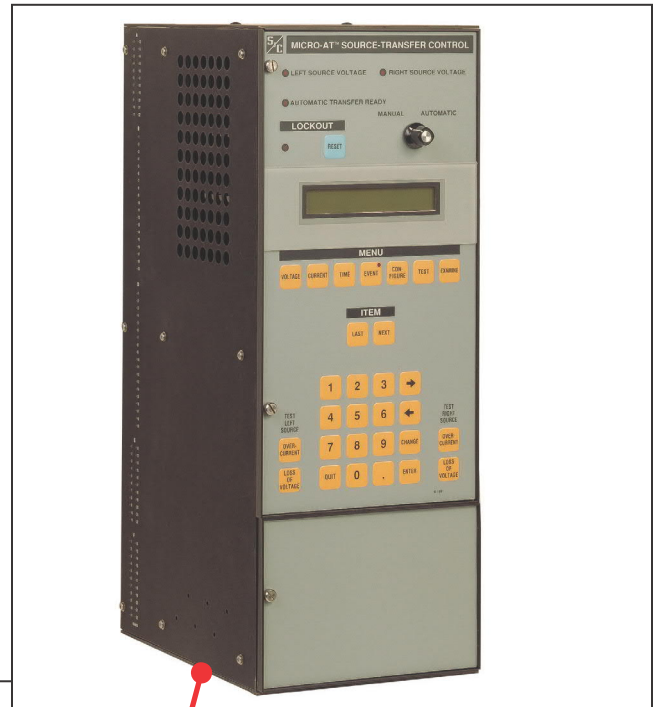

Figure 1. Micro-AT control installed in the S&C Source-Transfer Pad-Mounted Gear.



## Features

The Micro-AT Source-Transfer Control uses an electronic microprocessor to perform control operations, as directed by settings programmed into the device at the factory and in the field. Such settings—consisting of the control's operating characteristics and voltage-, current-, and time-related operating parameters—are entered into the control by means of a keypad on the front panel. See Figure 2 on page 3.

To simplify entry of this information and to permit its quick review on the LCD indicator, the operating characteristics have been grouped together as a series of items in the **Configure** menu. Similarly, the voltage-, current-, and time-related operating parameters have been grouped together as a series of items in the **Voltage, Current, and Time** menus, respectively. A particular item can be accessed for display by first pressing the appropriate menu key and then scrolling through the items, using the NEXT or LAST item key. To prevent unauthorized changes to the operating characteristics and operating parameters, each item is protected by an access code; the correct access code must be entered before the item can be altered.

The **Test** menu provides the means for checking the functioning of the source-transfer control and is also used to enable the test keys for simulating overcurrent and/or loss of voltage on the sources.

The Micro-AT Source-Transfer Control features powerful built-in diagnostic tools. The control automatically records system status and the status of the device's controller circuits every time a control operation occurs. Each such operation, referred to as an "event," is indicated by the illumination of a lamp on the EVENT menu key and is available for display under this menu. Further, the control has available for display, as items under the **Examine** menu, the present source voltage and current inputs and the present status of discrete inputs to and outputs from the control.

## Proven Solid-State Circuitry

S&C solid-state electronic devices offer the superior reliability and serviceability required for the rigors of operation in power equipment. Metal-oxide surge protectors at critical points in the control circuits provide optimum surge protection; S&C's unique surge control has been field-proven through years of successful application in hostile utility-substation environments. And the capability of every S&C electronic device to withstand voltage surges is confirmed by two factory quality-check tests: The ANSI Surge Withstand Capability Test (ANSI Standard C37.91.1); plus a much more severe (5-kV, 3.75-joule) capacitive-discharge test specially developed by S&C to duplicate or exceed voltage surges measured in Extra-High Voltage (EHV) power substations. The specified surges are applied at all terminals of the device. Additional tests are performed to identify and eliminate any components that might be prone to early failure. They include a dielectric test—a 72-hour screening test consisting of 24 hours at maximum-design operating temperatures followed by 48 hours of temperature cycling—and functional tests (both before and after the screening test).

Printed-circuit-board construction ensures high reliability. All components are applied at well below MIL-STD design guidelines, minimizing component stress, power-supply requirements, and internal heating. Voltage-level settings are maintained within  $\pm 3\%$  accuracy over an ambient temperature range of  $-40^{\circ}\text{F}$  ( $-40^{\circ}\text{C}$ ) to  $+160^{\circ}\text{F}$  ( $+71^{\circ}\text{C}$ ). Interconnecting-cable connector pins and receptacle contacts are gold-over-nickel plated. And all output relay contacts are silver alloy cadmium free to ensure long service life. Output circuits are relay isolated.

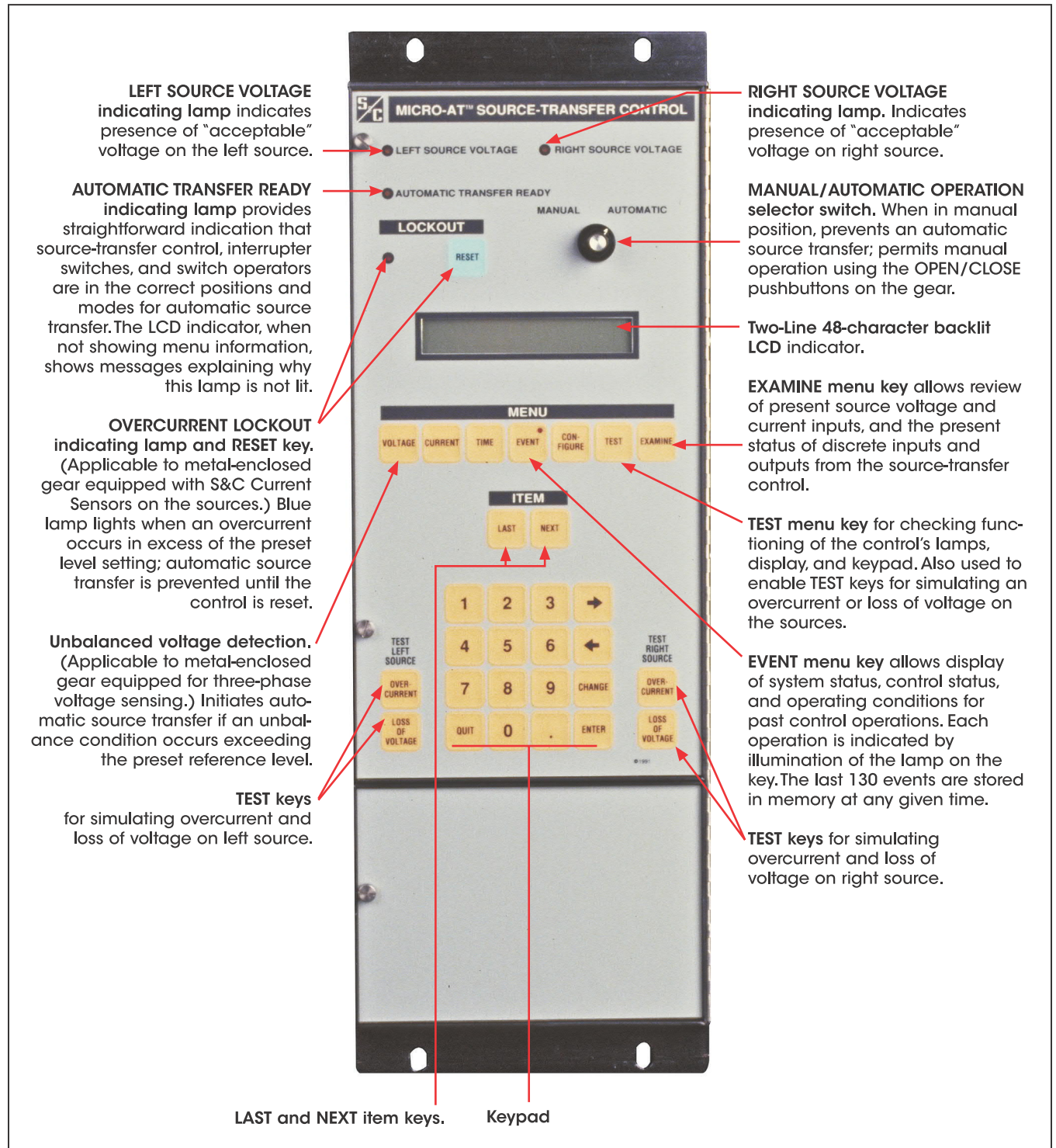

Figure 2. Close-up of front panel features.



## Common-Bus Primary-Selective System Applications

Under normal operating conditions in a common-bus primary-selective system, the preferred-source interrupter switch is closed and the alternate-source interrupter switch is open. See the top portion of Figure 3 on page 5.

The Micro-AT Source-Transfer Control monitors the condition of both power sources and initiates automatic switching when preferred-source voltage has been lost (or reduced below a predetermined level) for a period of time sufficient to confirm the loss is not transient. The preferred-source interrupter switch is automatically opened, and the alternate-source interrupter switch is then automatically closed, restoring service to the load.

Depending on how the control was field-programmed, Return To The Normal Circuit Configuration Preferred Source Interrupter Switch Closed, Alternate-Source Interrupter Switch Open operation may be performed automatically on restoration of normal voltage to the preferred source, after a delay sufficient to establish the return is not temporary (**Automatic Return** mode) or manually at a convenient time (**Hold Return** mode).

In the **Automatic Return** mode, return-of-source transfer may be accomplished with the Open Transition or Closed Transition schemes. With the Open Transition Retransfer scheme—used when the power sources are not to be paralleled—the alternate-source interrupter switch opens before the preferred-source interrupter switch closes with a momentary interruption of service to the load. With the Closed Transition Retransfer scheme—selected when it is permissible to parallel the sources so that there will be no interruption of service to the load—the alternate-source interrupter switch will open after the preferred-source interrupter switch closes. In the **Hold Return** mode, if the alternate-source voltage fails (and voltage has been restored to the preferred source), an Automatic Open-Transition Return-Of-Source Transfer operation will take place so the load is served from the preferred source.

## Split-Bus Primary-Selective System Applications

In a basic split-bus primary-selective system, the switchgear bus is divided into two sections by a bus-tie switch. See the bottom of Figure 3 on page 5. The switchgear normally operates with the two source interrupter switches closed

and the bus-tie interrupter switch open so each bus section receives power from its associated, separate source. Each source, in effect, is the preferred source for its section of the bus and the alternate source for the other section of bus. Typically, each source cable is sized for normal operating conditions and is loaded to rated capacity. Since under emergency conditions most installations have some loads which can be shed, it's not necessary for either source to carry the switchgear's total load over an extended period of time. Full use of both sources precludes the need for the serving utility to maintain idle substation and feeder capacity. And because the switchgear's load is segmented by the split bus, only a portion of the total load is transferred when a source is lost, greatly reducing the likelihood of the alternate source tripping out when transfer takes place.

The Micro-AT Source-Transfer Control monitors the condition of both power sources and initiates automatic switching when voltage on one source has been lost (or reduced below a predetermined level) for a period of time sufficient to confirm the loss is not transient. The interrupter switch associated with that source is automatically opened and the bus-tie interrupter switch is then automatically closed so all the loads are served from the remaining source.

Depending on how the control was field-programmed, a **Return to the Normal Circuit Configuration-Bus-Tie Interrupter Switch Open and Both Source Interrupter Switches Closed** operation may be performed automatically on restoration of normal voltage to the affected source after a delay sufficient to establish the return is not temporary (**Automatic Return** mode) or to be manually performed at a convenient time (**Hold Return** mode).

In the **Automatic Return** mode, return-of-source transfer may be accomplished with **Open Transition** or **Closed Transition** operations. With the Open Transition Retransfer scheme—used when the power sources are not to be paralleled—the bus-tie interrupter switch opens before the affected source interrupter switch closes with a momentary interruption of service to the load. With the Closed Transition Retransfer scheme—selected when it is permissible to parallel the sources so there will be no interruption of service to the load—the bus-tie interrupter switch opens after the affected source interrupter switch closes. In the **Hold Return** mode, if the source in use fails (and voltage has been restored to the other source), an Automatic Open-Transition Return-of-Source Transfer operation will take place so the load is served from the restored source.

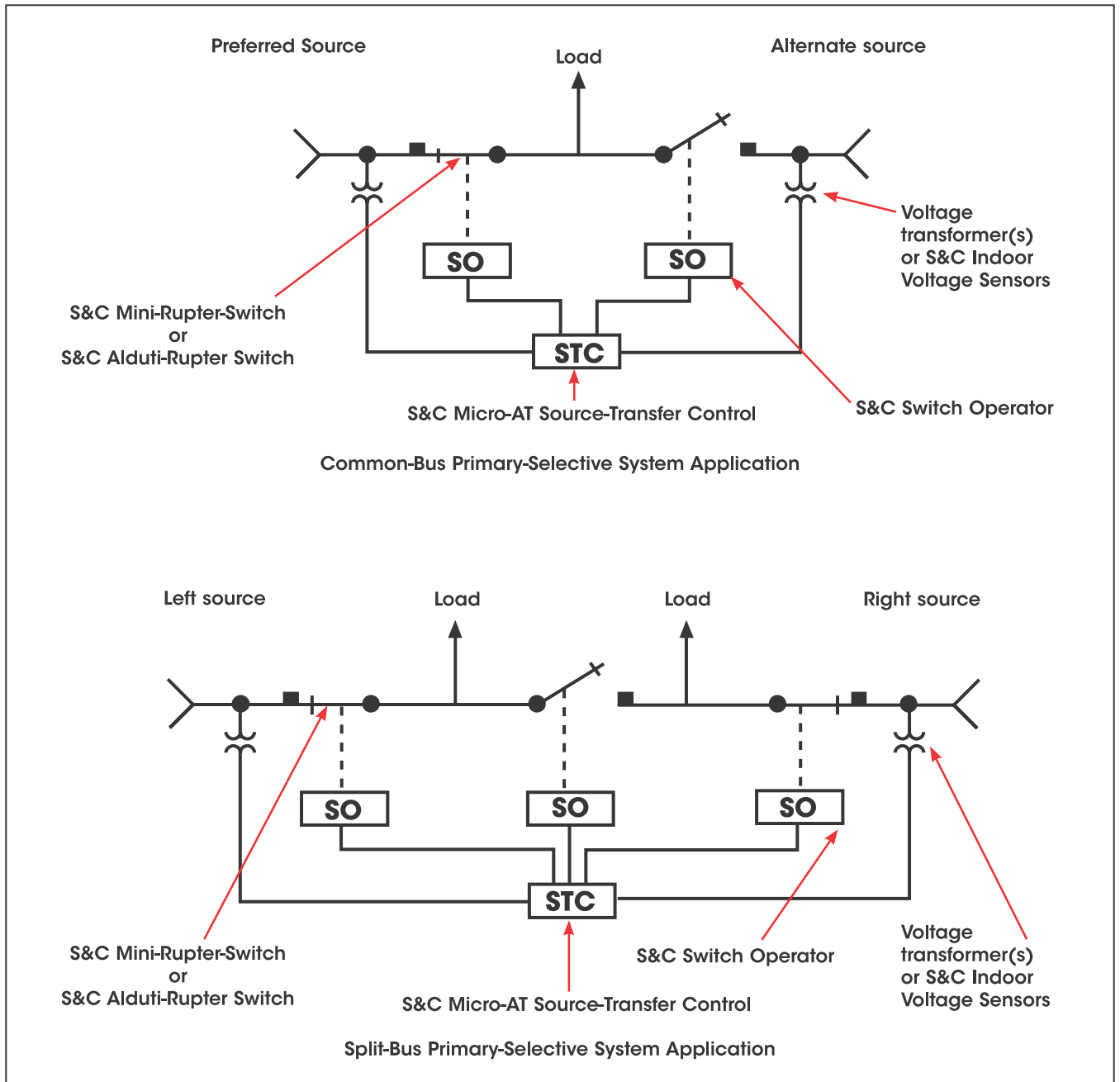

Figure 3. Application of Micro-AT Source-Transfer Controls in common-bus and split-bus primary-selective systems.

## Voltage Sensing

In S&C Metal-Enclosed Switchgear, the voltage-sensing input circuitry of the Micro-AT Source-Transfer Control accommodates either of the following single-phase or three-phase voltage-sensing schemes:

- For single-phase sensing, one line-to-ground connected voltage transformer per source
- For three-phase sensing, three line-to-ground connected voltage transformers, one line-to-ground connected voltage transformer and two S&C Indoor Voltage Sensors per source, or two line-to-line connected voltage transformers per source

In S&C Source-Transfer Pad-Mounted Gear, the voltage-sensing input circuitry of the Micro-AT control accommodates three-phase voltage sensing provided by three S&C Indoor Voltage Sensors per source.

In the event that, on either source, the voltage sensed by the voltage transformer or voltage sensor on phase 2 is higher or lower than the known output voltage of another voltage transformer on the system (as determined by independent measurement), the Micro-AT Source-Transfer Control may be field-programmed to **Set Base Left** and/or **Set Base Right** settings. In so doing, the voltage-sensing input circuitry of the source-transfer control is calibrated to this known voltage.

In instances where the metal-enclosed gear has been equipped for three-phase source voltage sensing, an output-voltage magnitude unbalance and/or phase-angle unbalance will likely exist between the sensing devices on each source. The Micro-AT Source-Transfer Control may be field programmed to **Normalize Left** and/or **Normalize Right** settings to compensate for such differences on the left source and the right source, respectively.

## Unbalance Detection

An **Unbalanced Voltage Detection** feature may be field programmed in the Micro-AT Source-Transfer Control in instances where the metal-enclosed gear has been equipped for three-phase voltage sensing. This feature protects the loads from any source-side open-phase condition at the same system voltage level as the metal-enclosed gear— whether caused by utility-line burn-down, broken conductors, single-phase switching, equipment malfunctions, or single-phasing resulting from blown source-side fuses. The unbalance detection feature continuously develops and monitors the negative-sequence voltage to detect any unbalance present as the result of an open-phase condition.

If the voltage unbalance exceeds a preset reference level for a period of time sufficient to confirm the loss is not transient, an output signal is produced that initiates automatic transfer to the other source. By monitoring negative-sequence voltage, the unbalance detection feature

detects virtually all source-side open-phase conditions, even those where backfeed defeats simple voltage-magnitude sensing schemes.

## Overcurrent Lockout

An **Overcurrent-Lockout** feature may be field-programmed in the Micro-AT Source-Transfer Control in instances where the metal-enclosed gear has been equipped with S&C Current Sensors on the sources. This feature prevents an automatic-transfer operation that would close a source interrupter switch or bus-tie interrupter switch into a fault, thereby avoiding further utility-system disturbance.

An overcurrent in excess of the preset level will activate the lockout circuit in the control. If the overcurrent is caused by a fault cleared by a source-side protective device, the prolonged loss of voltage will cause the associated source interrupter switch to open. At the same time, a **Lockout** mode will activate in the source-transfer control so the other source interrupter switch or the bus-tie interrupter switch will not automatically close into the fault. (If the overcurrent is caused by a fault that is cleared by a load-side protective device, however, there will be no prolonged loss of voltage, so the source-transfer control will not initiate any switching operations.)

The **Lockout** mode may be externally reset; however, a terminal block must be included in the metal-enclosed gear for attachment of user-furnished control wiring providing the appropriate reset signal.

## Supervisory Control

A **Supervisory-Control** feature may be field programmed in the Micro-AT Source-Transfer Control, permitting switch operation from a remote location. This feature also requires that the metal-enclosed gear be equipped with a terminal block for attachment of user-furnished control wiring providing the appropriate supervisory control signals.

## Remote Indication

A **Remote Indication** feature may be optionally furnished in the Micro-AT Source-Transfer Control. This feature permits remote monitoring of the presence or absence of source voltages, the **Manual** or **Automatic** operating mode, the status of the READY indicator, and the **Overcurrent Lockout** state. This feature requires that the metal-enclosed gear be equipped with a terminal block for attachment of user-furnished control wiring to remote indicators.

## Test Panel

A **Test Panel** feature may also be optionally furnished. This feature permits checkout of the source-transfer scheme, unbalance detection, and overcurrent lockout using an external, adjustable three-phase source.

**CITADEL**  
**ELECTRIC GROUP, INC.**  
31710 E. Colbern Rd. \* Oak Grove, MO 64075

E & S Excavating, LLC  
9300 Holmes Rd.  
Kansas City, MO. 64131

10/31/2022

Attn: Audrie Seeley

Regarding: MKC Airfield and Landside Design  
Kansas City, Missouri  
KCAD Project No. 62200529

Subject: Notice to Award Subcontract

Audrie Seeley,

Consider this letter as an intent for Citadel to award a subcontract to E&S Excavating, LLC if we are awarded the contract change order associated with Citadel's scope/proposal CCN#06 Rev1 Added S&C Switch w/Micro Switching.

Estimated excavation subcontract value: \$19,000.00

Respectfully,

Sean DesCombes  
Project Manager  
Citadel Electric Group

# ***E & S EXCAVATING, LLC***

**UTILITIES \* STRUCTURAL \* GRADING**

**9300 HOLMES ROAD  
KANSAS CITY, MO 64131**

**(816) 777-0192**

**FAX: (816) 777-0195**

Date: November 3, 2022  
Company: Citadel Electric  
Attn: Sean DesCombes

Project name: MKC Airfield Transformer Relocation

Gentleman:

We are pleased to submit for your consideration our proposal for the above referenced project. Our price for the work as per plans and specifications is: **NINETEEN THOUSAND AND FIVE DOLLARS AND NO CENTS (\$19,005.00)**

We have included the following in our proposal:

1. Mobilization and Demobilize to site
2. Machine excavate as needed to expose existing conduits to allow others to re-route to new switch
3. Backfill and compact all excavated areas with either on site spoils, or imported AB3
4. Haul off all spoils
5. Provide AB3 or Gravel subgrade for new Sectionalizer Pad
6. Finish grade area
7. Overseed with Fescue seed

We have excluded the following in our proposal:

1. Permits
2. Traffic control
3. Overtime
4. Layout/surveying
5. Testing
6. Bonding
7. Asphalt/concrete patch back
8. Asphalt/concrete demo
9. Saw cutting
10. Rock Excavation

We would like to offer the following alternates for your consideration:

0

---

---

We have seen the following addendum:  
0

Sincerely,

Eric O. Seeley  
President

**NOTE: Everything in the above proposal, if accepted, becomes part of the contract documents.**

-

BRANCH 61A  
3505 MANCHESTER TRFY  
KANSAS CITY MO 64129-1338  
816-921-8051  
816-861-0304 FAX

# 211339016

Job Site

MKC AVIATION  
10 NW RICHARDS RD  
KANSAS CITY MO 64116-4253

Office: 816-697-6643 Cell: 816-215-1848

Customer # : 798924  
Quote Date : 09/29/22  
Estimated Out : 06/05/23 12:00 PM  
Estimated In : 06/12/23 12:00 PM  
UR Job Loc : 10 NW RICHARDS RD, K  
UR Job # : 204  
Customer Job ID:  
P.O. # : TBD  
Ordered By : SEAN DESCOMBES  
Written By : DEREK TIMLER  
Salesperson : DEREK TIMLER

CITADEL ELECTRIC GROUP  
31710 E COLBERN RD  
OAK GROVE MO 64075-7284

**This is not an invoice  
Please do not pay from this document**

RENTAL ITEMS:							
Qty	Equipment	Description	Minimum	Day	Week	4 Week	Estimated Amt.
2	2403410	GENERATOR 600-699 KVA		2,493.00	3,116.00	8,568.00	6,232.00
*****							x2
* RATES ARE BASED ON SINGLE SHIFT OPERATIONS UNLESS							
* OTHERWISE STATED							24hr. run = (x2 factor) \$12,464.00
* SINGLE SHIFT = 8 HRS / DAY, 40 HRS / WEEK, 160 HRS / 4 WEEKS							
* DOUBLE SHIFT = 16 HRS / DAY, 80 HRS / WEEK, 320 HRS / 4 WEEKS							
* TRIPLE SHIFT = UNLIMITED USAGE							
* ** DOUBLE SHIFT IS 1.5 X SINGLE RATE **							
* ** TRIPLE SHIFT IS 2 X SINGLE RATE **							
*****							
* TO AVOID FUEL CHARGES THE UNIT MUST BE RETURNED WITH THE SAME							
* LEVEL OF FUEL IT HAD AT THE START OF THE RENTAL. YOU MAY OPT							
* FOR THE CONVENIENCE OF URI TO ARRANGE ONSITE FUELING SERVICES							
* AND INVOICE UPON YOUR REQUEST.							
*****							
30	241/7662	CABLE 4/0 AWG 400 AMP 50' CAM		22.00	28.00	77.00	840.00
30	241/5970	CABLE TAIL 4/0 MCAM BARE END	6.00	6.00	7.00	20.00	210.00
30	241/5980	CABLE TAIL 4/0 FCAM BARE END	6.00	6.00	7.00	20.00	210.00
1	2413697	TRANSFORMER 1250KVA MULTI TAP 480V 3PHASE DOWN TO 208V 3PHASE TRANSFORMER 1200AMP		2,098.00	2,099.00	2,100.00	2,099.00
							Rental Subtotal: 9,591.00
SALES/MISCELLANEOUS ITEMS:							
Qty	Item		Price		Unit of Measure		Extended Amt.
1	ENVIRONMENTAL SERVICE CHARGE	[ENV/MCI]	99.000		EACH		99.00
1	DELIVERY CHARGE		2500.000		EACH		2,500.00
1	PICKUP CHARGE		2500.000		EACH		2,500.00
							Sales/Misc Subtotal: 5,099.00
							Agreement Subtotal: 14,690.00
							Tax: 857.57
							Estimated Total: 15,547.57

COMMENTS/NOTES:

CONTACT: SEAN DESCOMBES  
CELL#: 816-215-1848

Estimated total: \$21,779.57

Fuel is estimated at 13 gals per hour @ 1/4 load  
Estimated fuel is \$6.00 per gallon  
7 days x 24hrs. x 1 generators = 168hrs of run time  
168hrs x 13 gallon per hour = 2184 gallons  
x2 generators = 4,368 gallons  
4,368 x \$6.16 per gallon = \$26,906.88

This proposal may be withdrawn if not accepted within 30 days. The above referenced Rental Protection Plan, environmental, and tax charges are estimates and are subject to change.

NOTICE: This is not a rental agreement. The rental of equipment and any items listed above is subject to availability and subject to the terms and conditions of the Rental and Service Agreement, which are available at <https://www.unitedrentals.com/legal/rental-service-terms-US> and which are incorporated herein by reference. A COPY OF THE RENTAL AND SERVICE AGREEMENT TERMS ARE AVAILABLE IN PAPER FORM UPON REQUEST.

**PART III - FEDERAL CONTRACT PROVISIONS FOR**  
**Non-AIP Funded Contracts**

**Application of References:**

“Contractor” means any party to this agreement other than the Owner, including without limitation the prime contractor. “Subcontractor” means all subcontractors under contract with the Contractor.

**Sec. A. Civil Rights General.** The Contractor agrees that it will comply with pertinent statutes, Executive Orders and such rules as are promulgated to ensure that no person shall, on the grounds of race, creed, color, national origin, sex, age, or disability be excluded from participating in any activity conducted with or benefiting from Federal assistance.

This provision binds the Contractor and subcontractors from the bid solicitation period through the completion of the contract. This provision is in addition to that required of Title VI of the Civil Rights Act of 1964.

**Sec. B. Civil Rights – Title VI Solicitation Notice.** The Kansas City Aviation Department, in accordance with the provisions of Title VI of the Civil Rights Act of 1964 (78 Stat.252, 42 U.S.C. §§ 2000d to 2000d-4) and the Regulations, hereby notifies all bidders or offerers that it will affirmatively ensure that any contract entered into pursuant to this advertisement, disadvantaged business enterprises will be afforded full and fair opportunity to submit bids in response to this invitation and will not be discriminated against on the grounds of race, color, or national origin in consideration for an award.

**Sec. C. Compliance with Nondiscrimination Requirements.** During the performance of this contract, the Contractor, for itself, its assignees, and successors in interest (hereinafter referred to as the “Contractor”) agrees as follows:

1. **Compliance with Regulations:** The Contractor (hereinafter includes Consultants) will comply with the Title VI List of Pertinent Nondiscrimination Acts and Authorities, as they may be amended from time to time, which are herein incorporated by reference and made a part of this contract.
2. **Non-discrimination:** The Contractor, with regard to the work performed by it during the contract, will not discriminate on the grounds of race, color, or national origin in the selection and retention of subcontractors, including procurements of materials and leases of equipment. The Contractor will not participate directly or indirectly in the discrimination prohibited by the Nondiscrimination Acts and Authorities, including employment practices when the contract covers any activity, project, or program set forth in Appendix B of 49 CFR Part 21.
3. **Solicitations for Subcontracts, Including Procurements of Materials and Equipment:** In all solicitations, either by competitive bidding, or negotiation made by the Contractor for work to be performed under a subcontract, including procurements of materials, or leases of equipment, each potential subcontractor or supplier will be



notified by the Contractor of the Contractor's obligations under this contract and the Nondiscrimination Acts And Authorities on the grounds of race, color, or national origin.

4. **Information and Reports:** The Contractor will provide all information and reports required by the Acts, the Regulations, and directives issued pursuant thereto and will permit access to its books, records, accounts, other sources of information, and its facilities as may be determined by the Sponsor or the Federal Aviation Administration to be pertinent to ascertain compliance with such Nondiscrimination Acts And Authorities and instructions. Where any information required of a Contractor is in the exclusive possession of another who fails or refuses to furnish the information, the Contractor will so certify to the Sponsor or the Federal Aviation Administration, as appropriate, and will set forth what efforts it has made to obtain the information.
5. **Sanctions for Noncompliance:** In the event of a Contractor's noncompliance with the non-discrimination provisions of this contract, the Sponsor will impose such contract sanctions as it or the Federal Aviation Administration may determine to be appropriate, including, but not limited to:
  - a. Withholding payments to the Contractor under the contract until the Contractor complies; and/or
  - b. Cancelling, terminating, or suspending a contract, in whole or in part.
6. **Incorporation of Provisions:** The Contractor will include the provisions of paragraphs one through six in every subcontract, including procurements of materials and leases of equipment, unless exempt by the Acts, the Regulations, and directives issued pursuant thereto. The Contractor will take action with respect to any subcontract or procurement as the Sponsor or the Federal Aviation Administration may direct as a means of enforcing such provisions including sanctions for noncompliance. Provided, that if the Contractor becomes involved in, or is threatened with litigation by a subcontractor, or supplier because of such direction, the Contractor may request the Sponsor to enter into any litigation to protect the interests of the Sponsor. In addition, the Contractor may request the United States to enter into the litigation to protect the interests of the United States.

**Sec. D. Title VI List of Pertinent Nondiscrimination Acts And Authorities.** During the performance of this contract, the Contractor, for itself, its assignees, and successors in interest (hereinafter referred to as the "Contractor") agrees to comply with the following non-discrimination statutes and authorities; including but not limited to:

- Title VI of the Civil Rights Act of 1964 (42 U.S.C. § 2000d et seq., 78 stat. 252), (prohibits discrimination on the basis of race, color, national origin);
- 49 CFR Part 21 (Non-discrimination In Federally-Assisted Programs of The Department of Transportation—Effectuation of Title VI of The Civil Rights Act of 1964);
- The Uniform Relocation Assistance and Real Property Acquisition Policies Act of 1970, (42

U.S.C. § 4601), (prohibits unfair treatment of persons displaced or whose property has been acquired because of Federal or Federal-aid programs and projects);

- Section 504 of the Rehabilitation Act of 1973, (29 U.S.C. § 794 et seq.), as amended, (prohibits discrimination on the basis of disability); and 49 CFR part 27;
- The Age Discrimination Act of 1975, as amended, (42 U.S.C. § 6101 et seq.), (prohibits discrimination on the basis of age);
- Airport and Airway Improvement Act of 1982, (49 USC § 471, Section 47123), as amended, (prohibits discrimination based on race, creed, color, national origin, or sex);
- The Civil Rights Restoration Act of 1987, (PL 100-209), (Broadened the scope, coverage and applicability of Title VI of the Civil Rights Act of 1964, The Age Discrimination Act of 1975 and Section 504 of the Rehabilitation Act of 1973, by expanding the definition of the terms “programs or activities” to include all of the programs or activities of the Federal-aid recipients, sub-recipients and contractors, whether such programs or activities are Federally funded or not);
- Titles II and III of the Americans with Disabilities Act of 1990, which prohibit discrimination on the basis of disability in the operation of public entities, public and private transportation systems, places of public accommodation, and certain testing entities (42 U.S.C. §§ 12131 – 12189) as implemented by U.S. Department of Transportation regulations at 49 CFR parts 37 and 38;
- The Federal Aviation Administration’s Non-discrimination statute (49 U.S.C. § 47123) (prohibits discrimination on the basis of race, color, national origin, and sex);
- Executive Order 12898, Federal Actions to Address Environmental Justice in Minority Populations and Low-Income Populations, which ensures non-discrimination against minority populations by discouraging programs, policies, and activities with disproportionately high and adverse human health or environmental effects on minority and low-income populations;
- Executive Order 13166, Improving Access to Services for Persons with Limited English Proficiency, and resulting agency guidance, national origin discrimination includes discrimination because of limited English proficiency (LEP). To ensure compliance with Title VI, you must take reasonable steps to ensure that LEP persons have meaningful access to your programs (70 Fed. Reg. at 74087 to 74100);
- Title IX of the Education Amendments of 1972, as amended, which prohibits you from discriminating because of sex in education programs or activities (20 U.S.C. 1681 et seq).

**Sec. E. Federal Fair Labor Standards Act (Federal Minimum Wage).** All contracts and subcontracts that result from this solicitation incorporate by reference the provisions of 29 CFR Part 201, the Federal Fair Labor Standards Act (FLSA), with the same force and effect as if given in full text. The FLSA sets minimum wage, overtime pay, recordkeeping, and child labor standards

for full and part time workers. The Contractor has full responsibility to monitor compliance to the referenced statute or regulation. The Contractor must address any claims or disputes that arise from this requirement directly with the U.S. Department of Labor – Wage and Hour Division.

**Sec. F. Occupational Safety and Health Act of 1970.** All contracts and subcontracts that result from this solicitation incorporate by reference the requirements of 29 CFR Part 1910 with the same force and effect as if given in full text. The employer must provide a work environment that is free from recognized hazards that may cause death or serious physical harm to the employee. The employer retains full responsibility to monitor its compliance and their subcontractor's compliance with the applicable requirements of the Occupational Safety and Health Act of 1970 (20 CFR Part 1910). The employer must address any claims or disputes that pertain to a referenced requirement directly with the U.S. Department of Labor – Occupational Safety and Health Administration.

**Sec. G. Right to Amend.** In the event that the Federal Aviation Administration or its successors requires modifications or changes in this Agreement as a condition precedent to the granting of funds for the improvement of the Airport, or otherwise, the Contractor agrees to consent to such amendments, modifications, revisions, supplements, or deletions of any of the terms, conditions, or requirements of this Agreement as may be reasonably required.

**Sec. H. Immigration and Control Act of 1986.** Contractor understands and acknowledges the applicability of the IRCA to it. Contractor agrees to comply with the provisions of IRCA as it applies to its activities under this Contract and to permit the City to inspect its personnel records to verify such compliance.

**Sec. I. Additional Records Requirements.** In addition to the requirements related to Records in Part II of this Contract, the Federal Aviation Administration and the Comptroller General of the United States or any of their duly authorized representatives shall have a right to examine or audit all Records and Contractor shall provide access to them of all Records upon ten (10) days written notice.

**Sec. J. Restricted Areas/Safety.** Contractor will comply with any and all applicable present and future rules, regulations, restrictions, ordinances, statutes, laws and/or orders of any federal, state or local governmental entity regarding airfield security. Contractor shall fully comply with applicable provisions of the Code of Federal Regulations (CFR) Title 49: Transportation. Contractor shall fully comply specifically with 49 CFR Part 1540 – Civil Aviation Security; 49 CFR Part 1542 – Airport Security; 49 CFR Part 1544 – Aircraft Operator Security: Air Carriers and commercial Operators (if Contractor is an air carrier); and 49 CFR Part 1546 – Foreign Air Carrier Security (if Contractor is a foreign air carrier). City has adopted a Security Plan for the Airport approved by the Transportation Security Administration (TSA) pursuant to Department of Transportation (DOT) TSA CFR 49 1542. Contractor agrees to be bound by and follow the Airport Security Plan. Any access to the Airport granted to Contractor shall not be used, enjoyed or extended to any person, entity or vehicle engaged in any activity or performing any act or furnishing any service for or on behalf of the Contractor that Contractor is not authorized to engage in or perform under this Contract unless expressly authorized in writing by the Director in accordance with TSA CFR 49 1542. In the event Contractor, its officer, employees, invitees or Contractors cause or contribute to unauthorized persons or vehicles entering the air operations

areas of the Airport, or otherwise violate the Security Plan or any laws, regulations, rules, etc. governing airport security, and in addition to any other remedies available hereunder, Contractor shall be liable to City for an amount equal to any civil penalty imposed on City for such violations and hereby agrees to indemnify City for any such federal civil penalties, provided City shall promptly notify Contractor in writing of any claimed violations so as to permit Contractor an opportunity to participate in any investigation or proceedings.