

# FINAL PLAT - PROJECT VELVET

LOCATED IN THE NORTH 1/2 OF SECTION 15, LYING IN CLAY COUNTY, MISSOURI, FRACTIONAL NW 1/4 OF SECTION 15, AND EAST 1/2 OF THE NE 1/4 OF SECTION 16, ALL IN TOWNSHIP 52 NORTH, RANGE 33 WEST OF THE FIFTH PRINCIPAL MERIDIAN IN KANSAS CITY, PLATTE COUNTY, MISSOURI

## NOTES

- THE BASIS OF BEARINGS FOR THIS PRELIMINARY PLAT ARE GRID BEARINGS
- A PART OF THE SUBJECT PROPERTY LIES IN AN AREA LABELED ZONE "X" (AREAS DETERMINED TO BE OUTSIDE OF THE 500-YEAR FLOOD PLAIN) AND A PART OF THE SUBJECT PROPERTY LIES IN AN AREA LABELED ZONE "AE" (BASE FLOOD ELEVATION DETERMINED) AS DETERMINED BY THE FEMA FLOOD INSURANCE RATE MAP NUMBER 2901790053G WITH A MAP DATE OF JANUARY 20, 2017
- EXISTING BOUNDARY LINEWORK BASED ON ALTA SURVEY COMPLETED BY MCCLURE ENGINEERING DATED 6/10/2020 AND VERIFIED BY WILSON & COMPANY TO MEET MISSOURI MINIMUM STANDARDS FOR PROPERTY BOUNDARY SURVEYS (2 CSR 90-60), NOVEMBER 2021
- THE ALTA SURVEY COMPLETED BY MCCLURE ENGINEERING DATED 6/10/2020 REFERENCES FIRST AMERICAN TITLE POLICY NUMBER 5011429-0200353E. THE POLICY EXCEPTION FROM COVERAGE NUMBER 15 REFERENCES BOOK T AT PAGE 235. SAID DOCUMENT REFERS TO A 5/100 ACRE EXCEPTION FOR BURYING GROUND THAT IS NOT PLOTTABLE, AND NO EVIDENCE WAS FOUND DURING THE COURSE OF THE SURVEY.
- ALL COORDINATES AND ALL BEARINGS AS SHOWN ARE BASED ON "MISSOURI COORDINATE SYSTEM OF 1983, WEST ZONE" USING A COMBINED GRID FACTOR OF 0.99986406
- ALL STORMWATER MANAGEMENT FACILITIES WILL BE PRIVATELY MAINTAINED
- CURRENT KANSAS CITY, MISSOURI ZONING: MPD

THE UNDERSIGNED PROPRIETOR OF THE PROPERTY DESCRIBED HEREON LYING IN THE CITY OF KANSAS CITY, CLAY COUNTY, MISSOURI, HAS CAUSED THE SAME TO BE SPLIT IN THE MANNER SHOWN ON THE ACCOMPANYING PLAT, AND AS DESCRIBED HEREON.

VELVET TECH SERVICES, LLC, OWNER / DEVELOPER

STATE OF MISSOURI )  
 ) SS  
 COUNTY OF CLAY )

BE IT REMEMBERED THAT ON THIS \_\_\_\_\_ DAY OF \_\_\_\_\_, 20\_\_\_\_, BEFORE ME, THE UNDERSIGNED, A NOTARY PUBLIC IN AND FOR THE COUNTY AND STATE AFORESAID, CAME VELVET TECH SERVICES, LLC PERSONALLY KNOWN TO ME, WHO BEING DULY SWORN DID SAY THAT THEY ARE THE OWNERS OF THE ABOVE DESCRIBED PROPERTY AND THIS LOT ADJUSTMENT IS BY THEIR VOLUNTARY ACT AND DEED.

IN WITNESS WHEREOF, I HAVE HEREUNTO SET MY HAND AND AFFIXED MY OFFICIAL SEAL AT MY OFFICE THE DAY AND YEAR LAST WRITTEN.

NOTARY PUBLIC IN AND FOR CLAY COUNTY, MISSOURI

MY COMMISSION EXPIRES

CITY PLAN COMMISSION

APPROVED:

COUNCIL  
 THIS IS TO CERTIFY THAT THE WITHIN PLAT WAS DULY SUBMITTED TO AND APPROVED BY THE COUNCIL OF KANSAS CITY, MISSOURI, BY ORDINANCE NO. \_\_\_\_\_ DULY AUTHENTICATED AS PASSED THIS \_\_\_\_\_ DAY OF \_\_\_\_\_, 20\_\_\_\_.

PUBLIC WORKS DEPARTMENT

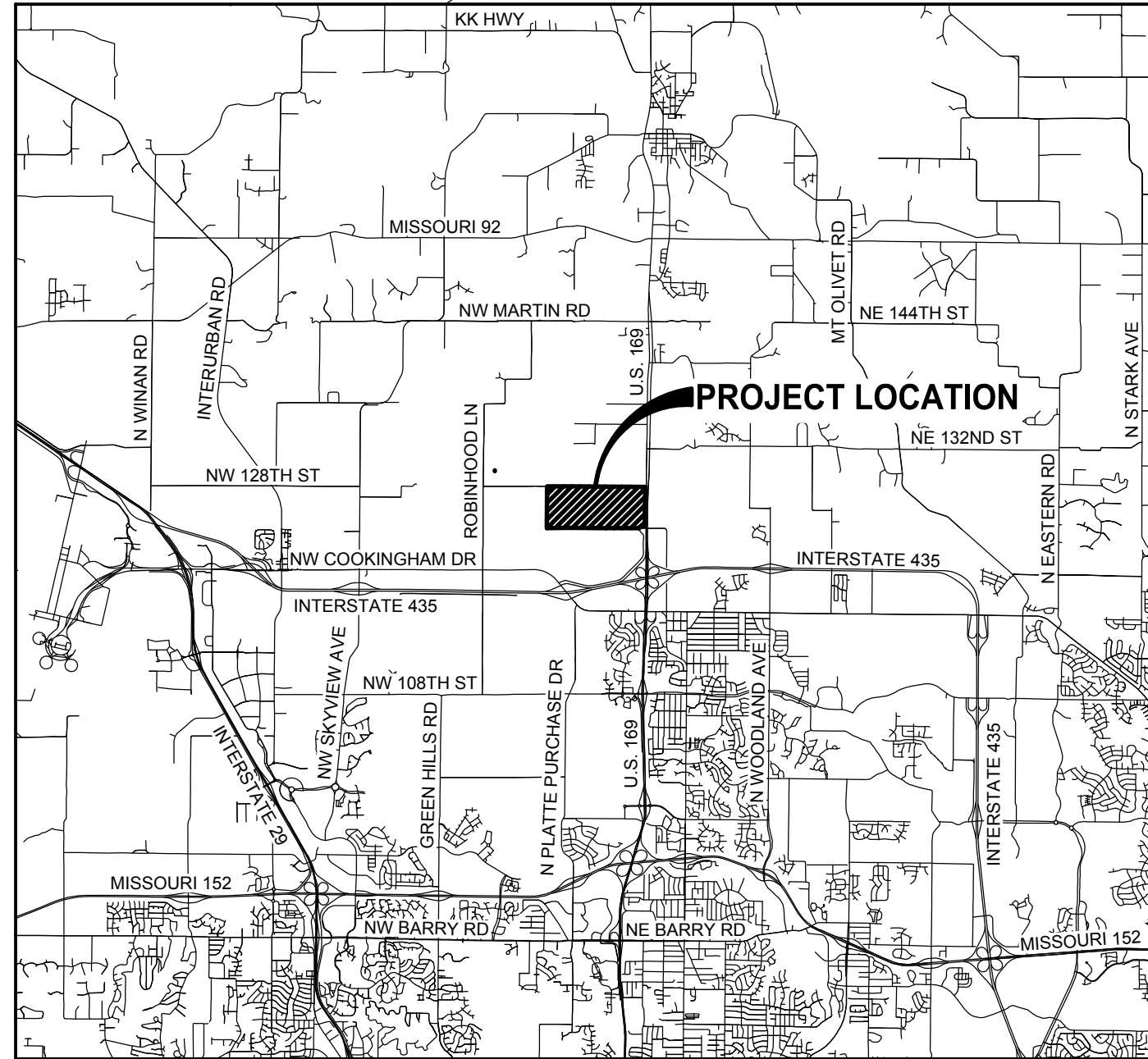

VICINITY MAP  
Not To Scale

Line #	Direction	Length
L10	N90°00'00"E	157.75'
L11	S31°03'09"E	274.69'
L12	S00°00'00"E	240.06'
L13	N90°00'00"W	299.44'
L14	N00°00'00"E	475.38'
L15	N90°00'00"W	107.86'
L16	N78°21'40"W	506.42'
L17	N16°56'43"W	199.10'
L18	N90°00'00"W	2879.54'
L19	N00°00'00"E	229.18'
L20	N90°00'00"E	2988.99'
L21	S51°26'41"E	706.45'
L22	S00°00'00"E	81.50'
L23	N89°43'21"W	176.05'
L24	N30°00'00"W	337.09'
L25	N51°23'20"E	109.51'
L26	S89°59'45"E	260.74'
L27	S00°16'18"W	361.10'

Line #	Direction	Length
L28	N44°45'51"W	22.10'
L29	N45°31'06"E	231.37'
L30	N74°12'28"E	364.51'
L31	N90°00'00"E	651.04'
L32	S00°00'00"E	30.00'
L33	N90°00'00"E	646.88'
L34	N74°12'28"E	352.67'
L35	N45°31'06"E	228.39'
L36	N13°13'33"W	9.24'

Line #	Direction	Length
L37	S89°49'18"E	1361.99'
L38	S89°35'11"E	669.75'
L39	S89°35'11"E	1284.73'
L40	S89°37'57"E	1441.10'
L41	S89°40'04"E	594.27'
L42	S44°37'57"E	115.78'
L43	S00°16'18"W	1708.53'
L77	S67°18'34"E	65.30'

Line #	Direction	Length
L44	S89°49'18"E	39.84'
L45	S51°18'44"W	147.10'
L46	N38°41'16"W	25.00'
L47	N51°18'44"E	116.08'
L48	N89°37'57"W	17.22'
L49	S89°37'57"E	15.45'
L50	S28°12'21"E	47.55'
L51	S62°09'47"W	20.00'
L52	N28°12'21"W	58.31'
L53	S00°22'03"W	39.43'
L54	N89°37'57"W	20.00'
L55	N00°22'03"E	39.42'
L56	S89°40'04"E	20.00'
L57	N44°37'57"W	96.05'

Line #	Direction	Length
L58	S89°37'57"E	68.27'
L59	S00°40'12"W	67.92'
L60	N89°14'04"W	32.11'
L61	N00°45'56"E	20.00'
L62	S89°14'04"E	31.93'
L63	S00°16'18"W	20.00'
L64	N90°00'00"W	35.47'
L65	N00°00'00"E	20.00'
L66	N90°00'00"E	35.57'
L67	S00°16'18"W	20.00'
L68	N89°43'42"W	64.30'
L69	N00°16'18"E	40.00'
L70	S89°43'42"E	64.30'
L71	S00°16'18"W	40.00'

Line #	Direction	Length
L1	S00°01'25"W	246.88'
L2	N00°10'42"E	246.96'
L3	N00°00'00"E	334.47'
L4	S00°00'00"E	334.47'
L5	N90°00'00"E	350.00'
L6	S00°00'00"E	700.00'
L7	N90°00'00"W	392.00'
L8	N00°00'00"E	700.00'
L9	N90°00'00"E	18.00'

Curve #	Length	Radius	Delta	CHD B	CHD L
C1	129.35'	188.00'	39°25'16"	S19°42'38"E	126.81'
C2	145.86'	212.00'	39°25'16"	N19°42'38"W	143.00'
C3	129.35'	188.00'	39°25'16"	N19°42'38"W	126.81'
C4	145.86'	212.00'	39°25'16"	S19°42'38"E	143.00'

Curve #	Length	Radius	Delta	CHD B	CHD L
C5	314.13'	405.00'	44°26'24"	S27°08'19"E	306.31'
C6	400.19'	462.00'	49°37'49"	S24°32'37"E	387.80'

## LEGAL DESCRIPTION

ALL THAT PART OF THE NORTH ONE-HALF (1/2) OF SECTION 15, TOWNSHIP 52 NORTH, RANGE 33 WEST, LYING IN CLAY COUNTY, MISSOURI, AND ALL THAT PART OF THE FRACTIONAL NORTHWEST QUARTER OF SECTION 15, AND THE EAST 74 ACRES OF THE EAST ONE-HALF (1/2) OF THE NORTHEAST QUARTER OF SECTION 16, ALL IN TOWNSHIP 52 NORTH, RANGE 33 WEST, AS DESCRIBED AND RECORDED IN PLATTE COUNTY, MISSOURI, AS INSTRUMENT NUMBER 2020025260, IN BOOK 8743, PAGE 64, BEING MORE PARTICULARLY DESCRIBED AS FOLLOWS:

BEGINNING AT A 1/2" IRON BAR FOUND AT THE NORTH END OF A BOUNDARY LINE AGREEMENT DESCRIBED IN BOOK 291, PAGE 30, THENCE S 89° 49' 21" E, ALONG THE NORTH LINE OF THE NORTHEAST QUARTER OF SAID SECTION 16, A DISTANCE OF 1223.14 FEET TO A FOUND 1/2" IRON BAR WITH PLASTIC CAP STAMPED MO1303;  
 THENCE S 89° 49' 41" E, ALONG THE NORTH LINE OF SAID FRACTIONAL NORTHWEST QUARTER OF SECTION 15 IN SAID PLATTE COUNTY, A DISTANCE OF 490.26 FEET TO A FOUND 1/2" IRON BAR WITH PLASTIC CAP;  
 THENCE N 00° 40' 08" E, ALONG THE COUNTY LINE BETWEEN SAID CLAY COUNTY AND SAID PLATTE COUNTY, A DISTANCE OF 9.59 FEET TO A FOUND 1/2" IRON BAR WITH ALUMINUM CAP;  
 THENCE S 89° 35' 11" E, ALONG THE NORTH LINE OF SAID FRACTIONAL NORTHWEST QUARTER OF SECTION 15 IN SAID PLATTE COUNTY, A DISTANCE OF 1954.68 FEET TO A FOUND 1/2" REBAR;  
 THENCE S 89° 37' 57" E A DISTANCE OF 2114.31 FEET TO THE NEW WEST RIGHT OF WAY LINE FOR OUTER ROAD DESCRIBED IN MISSOURI DEPARTMENT OF TRANSPORTATION PLANS FOR JOB NUMBER 20-0268;  
 THENCE S 00° 40' 12" W, ALONG SAID WEST RIGHT OF WAY LINE, A DISTANCE OF 79.59 FEET TO THE SOUTHWEST CORNER OF THE RIGHT OF WAY DEDICATED FOR NW 128TH STREET;  
 THENCE S 00° 40' 12" W, CONTINUING ALONG SAID WEST RIGHT OF WAY LINE, A DISTANCE OF 67.92 FEET;  
 THENCE S 89° 23' 41" E, CONTINUING ALONG SAID WEST RIGHT OF WAY LINE, A DISTANCE OF 26.93 FEET;  
 THENCE CONTINUING ALONG SAID WEST RIGHT OF WAY LINE ON A CURVE TO THE LEFT AN ARC DISTANCE OF 331.37 FEET, SAID CURVE TO THE LEFT HAVING A RADIUS OF 380.00 FEET, A CHORD BEARING OF S 24° 22' 36" E AND A CHORD DISTANCE OF 320.97 FEET;  
 THENCE CONTINUING ALONG SAID WEST RIGHT OF WAY LINE ON A CURVE TO THE RIGHT AN ARC DISTANCE OF 421.85 FEET, SAID CURVE TO THE RIGHT HAVING A RADIUS OF 487.00 FEET, A CHORD BEARING OF S 24° 32' 37" E AND A CHORD DISTANCE OF 408.78 FEET;  
 THENCE S 00° 16' 18" W, CONTINUING ALONG SAID WEST RIGHT OF WAY LINE, A DISTANCE OF 1704.95 FEET TO A POINT ON THE NORTH RIGHT OF WAY LINE FOR NW 124TH STREET;  
 THENCE S 82° 07' 38" W, ALONG SAID NORTH RIGHT OF WAY LINE, A DISTANCE OF 266.85 FEET TO A FOUND RIGHT OF WAY MARKER ON THE WEST RIGHT OF WAY LINE FOR NW 124TH STREET;  
 THENCE S 00° 15' 26" W, ALONG SAID WEST RIGHT OF WAY LINE, A DISTANCE OF 75.02 FEET TO A FOUND 1/2" IRON BAR WITH PLASTIC CAP STAMPED "M02004" ON THE SOUTH LINE OF THE NORTHEAST QUARTER OF SAID SECTION 15;  
 THENCE N 89° 43' 21" W, ALONG SAID SOUTH LINE, A DISTANCE OF 2183.48 FEET TO A FOUND 5/8" REBAR AT THE SOUTHWEST CORNER OF SAID NORTHEAST QUARTER;  
 THENCE N 89° 40' 36" W, ALONG THE SOUTH LINE OF THE FRACTIONAL NORTHWEST QUARTER OF SAID SECTION 15 IN SAID CLAY COUNTY, A DISTANCE OF 1956.62 FEET TO A 1/2" IRON BAR WITH "MEC" CAP AT THE SOUTHWEST CORNER OF SAID FRACTIONAL NORTHWEST QUARTER IN SAID CLAY COUNTY;  
 THENCE S 00° 21' 21" W, ALONG THE COUNTY LINE BETWEEN SAID CLAY COUNTY AND SAID PLATTE COUNTY, A DISTANCE OF 5.61 FEET TO A FOUND 1/2" IRON BAR WITH PLASTIC CAP STAMPED "LS1989" FOUND AT THE SOUTHEAST CORNER OF THE FRACTIONAL NORTHWEST QUARTER OF SAID SECTION 15 IN SAID PLATTE COUNTY;  
 THENCE N 89° 46' 12" W, ALONG THE SOUTH LINE OF SAID FRACTIONAL NORTHWEST QUARTER OF SAID SECTION 15, A DISTANCE OF 496.46 FEET TO A 5/8" REBAR FOUND AT THE SOUTHEAST CORNER OF THE NORTHEAST QUARTER OF SAID SECTION 16;  
 THENCE S 89° 37' 16" W, ALONG THE SOUTH LINE OF SAID NORTHEAST QUARTER, A DISTANCE OF 1222.85 FEET TO A 1/2" IRON BAR WITH PLASTIC CAP STAMPED "LS1989" FOUND AT THE SOUTH END OF SAID BOUNDARY LINE AGREEMENT;  
 THENCE N 00° 28' 45" E, ALONG SAID BOUNDARY LINE AGREEMENT, A DISTANCE OF 2571.80 FEET TO A 5/8" REBAR WITH ALUMINUM CAP SET AT THE SOUTHWEST CORNER OF THE RIGHT OF WAY DEDICATED FOR NW 128TH STREET;  
 THENCE N 00° 28' 45" E, CONTINUING ALONG SAID BOUNDARY LINE AGREEMENT, A DISTANCE OF 70.33 FEET TO THE POINT OF BEGINNING.

CONTAINING 15,934,167 SQUARE FEET OR 365.80 ACRES, MORE OR LESS.

## PLAT DEDICATION

THE UNDERSIGNED PROPRIETOR OF THE ABOVE DESCRIBED TRACT OF LAND HAS CAUSED THE SAME TO BE SUBDIVIDED IN THE MANNER SHOWN ON THE ACCOMPANYING PLAT, WHICH SUBDIVISION SHALL BE HEREAFTER KNOWN AS "PROJECT VELVET".

## EASEMENTS

AN EASEMENT IS HEREBY GRANTED TO CLAY COUNTY, MISSOURI, AS TRUSTEE OF THE PUBLIC FOR LOCATING, CONSTRUCTING, OPERATING, AND MAINTAINING FACILITIES FOR WATER, GAS, ELECTRICITY, SEWAGE, TELEPHONE, CABLE TV AND SURFACE DRAINAGE, INCLUDING BUT NOT LIMITED TO UNDERGROUND PIPES AND CONDUITS, PAD MOUNTED TRANSFORMERS, SERVICE PEDESTALS, ANY OR ALL OF THEM UPON, OVER, UNDER AND ALONG THE STRIPS OF LAND DESIGNATED AS UTILITY EASEMENTS (U/E), WHERE OTHERS ARE DESIGNATED FOR A PARTICULAR PURPOSE, THE USE THEREOF SHALL BE LIMITED TO THAT PURPOSE ONLY. ALL THE ABOVE EASEMENTS SHALL BE KEPT FREE FROM ANY AND ALL OBSTRUCTIONS WHICH WOULD INTERFERE WITH THE CONSTRUCTION OR RECONSTRUCTION, PROPER SAFE AND CONTINUOUS MAINTENANCE OF THE AFORESAID USES AND SPECIFICALLY THERE SHALL NOT BE BUILT THEREON OR THEREOVER ANY STRUCTURE (EXCEPT DRIVEWAYS, PAVED AREAS, GRASS, SHRUBS AND FENCES) NOR SHALL THERE BE ANY OBSTRUCTION TO INTERFERE WITH THE AGENTS AND EMPLOYEES OF CLAY COUNTY, MISSOURI, AND ITS FRANCHISED UTILITIES FROM GOING UPON SAID EASEMENT AND AS MUCH OF THE ADJOINING LANDS AS MAY BE REASONABLY NECESSARY IN EXERCISING THE RIGHTS GRANTED BY THE EASEMENT. NO EXCAVATION OR FILL SHALL BE MADE OR OPERATION OF ANY KIND OR NATURE SHALL BE PERFORMED WHICH WILL REDUCE OR INCREASE THE EARTH COVERAGE OVER THE UTILITIES ABOVE STATED OR THE APPURTENANCES THERETO WITHOUT THE WRITTEN APPROVAL OF THE CLAY COUNTY PLANNING AND ZONING DIRECTOR.

## STREETS

THE STREETS SHOWN ON THIS PLAT AND NOT HERETOFORE DEDICATED TO PUBLIC USE ARE HEREBY SO DEDICATED.

## CERTIFICATION

I, WILLIAM E. KNIGHT, A REGISTERED LAND SURVEYOR IN THE STATE OF MISSOURI CERTIFY THAT THIS SURVEY WAS PERFORMED BY ME OR UNDER MY DIRECT SUPERVISION, WAS MADE IN ACCORDANCE WITH THE MISSOURI MINIMUM STANDARDS FOR BOUNDARY SURVEYS AND IS TRUE AND CORRECT TO THE BEST OF MY KNOWLEDGE AND BELIEF.

*William E. Knight* 01/07/2022  
 WILLIAM E. KNIGHT PLS-2007000077 DATE

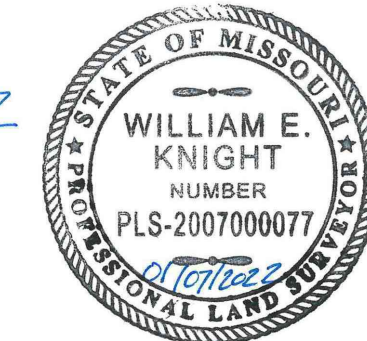

Line #	Direction	Length
L72	S00°00'08"E	60.47'
L73	S52°38'35"E	932.18'
L74	S00°00'00"E	395.88'

Curve #	Length	Radius	Delta	CHD B	CHD L
C7	30.87'	35.00'	50°32'34"	S49°01'38"W	29.88'
C8	171.11'	65.00'	150°49'49"	N80°49'45"W	125.81'

Line #	Direction	Length
L75	S89°49'18"E	15.55'
L76	S89°49'18"E	146.77'

SHEET NO.: 1 OF 2  
 INFORMATION: COVER SHEET  
 2 OF 2 PROJECT VELVET PLAT

NO.	REVISION-DESCRIPTION	BY	DATE	CHKD	APPD	SHEET NO.: 1 OF 2 SCALE: NOT TO SCALE PROJECT NO.: 21-300-248-00 DRAWN BY: TRZ DATE: 12/22/2021 CHECKED BY: WEK DATE: 12/22/2021 APPROVED BY:	WILSON & COMPANY 900 East 101st Terrace, Suite 200 Kansas City, MO 64131 Phone: 816-701-3100 Fax: 816-942-3013 FINAL PLAT MASTER PLANNED DEVELOPMENT (MPD) PROJECT VELVET 128TH ST AND ARROWHEAD TRAFFICWAY KANSAS CITY, MO 64165 CLAY/PLATTE COUNTY
-----	----------------------	----	------	------	------	--	--



# FINAL PLAT - PROJECT VELVET

LOCATED IN THE NORTH 1/2 OF SECTION 15, LYING IN CLAY COUNTY, MISSOURI, FRACTIONAL NW 1/4 OF SECTION 15, AND EAST 1/2 OF THE NE 1/4 OF SECTION 16, ALL IN TOWNSHIP 52 NORTH, RANGE 33 WEST OF THE FIFTH PRINCIPAL MERIDIAN IN KANSAS CITY, PLATTE COUNTY, MISSOURI

## NOTES

1. THE BASIS OF BEARINGS FOR THIS PRELIMINARY PLAT ARE GRID BEARINGS
2. A PART OF THE SUBJECT PROPERTY LIES IN AN AREA LABELED ZONE "X" (AREAS DETERMINED TO BE OUTSIDE OF THE 500-YEAR FLOOD PLAIN) AND A PART OF THE SUBJECT PROPERTY LIES IN AN AREA LABELED ZONE "AE" (BASE FLOOD ELEVATION DETERMINED) AS DETERMINED BY THE FEMA FLOOD INSURANCE RATE MAP NUMBER 2901790053G WITH A MAP DATE OF JANUARY 20, 2017
3. EXISTING BOUNDARY LINEWORK BASED ON ALTA SURVEY COMPLETED BY MCCLURE ENGINEERING DATED 6/10/2020 AND VERIFIED BY WILSON & COMPANY TO MEET MISSOURI MINIMUM STANDARDS FOR PROPERTY BOUNDARY SURVEYS (2 CSR 90-60), NOVEMBER 2021
4. THE ALTA SURVEY COMPLETED BY MCCLURE ENGINEERING DATED 6/10/2020 REFERENCES FIRST AMERICAN TITLE POLICY NUMBER 5011429-0200353E. THE POLICY EXCEPTION FROM COVERAGE NUMBER 15 REFERENCES BOOK T AT PAGE 235. SAID DOCUMENT REFERS TO A 5/100 ACRE EXCEPTION FOR BURYING GROUND THAT IS NOT PLOTTABLE, AND NO EVIDENCE WAS FOUND DURING THE COURSE OF THE SURVEY.
5. ALL COORDINATES AND ALL BEARINGS AS SHOWN ARE BASED ON "MISSOURI COORDINATE SYSTEM OF 1983, WEST ZONE" USING A COMBINED GRID FACTOR OF 0.99986406
6. ALL STORMWATER MANAGEMENT FACILITIES WILL BE PRIVATELY MAINTAINED
7. CURRENT KANSAS CITY, MISSOURI ZONING: MPD

THE UNDERSIGNED PROPRIETOR OF THE PROPERTY DESCRIBED HEREON LYING IN THE CITY OF KANSAS CITY, PLATTE COUNTY, MISSOURI, HAS CAUSED THE SAME TO BE SPLIT IN THE MANNER SHOWN ON THE ACCOMPANYING PLAT, AND AS DESCRIBED HEREON.

VELVET TECH SERVICES, LLC, OWNER / DEVELOPER

STATE OF MISSOURI)

SS

COUNTY OF PLATTE)

BE IT REMEMBERED THAT ON THIS \_\_\_\_\_ DAY OF \_\_\_\_\_, 20\_\_\_\_, BEFORE ME, THE UNDERSIGNED, A NOTARY PUBLIC IN AND FOR THE COUNTY AND STATE AFORESAID, CAME VELVET TECH SERVICES, LLC PERSONALLY KNOWN TO ME, WHO BEING DULY SWORN DID SAY THAT THEY ARE THE OWNERS OF THE ABOVE DESCRIBED PROPERTY AND THIS LOT ADJUSTMENT IS BY THEIR VOLUNTARY ACT AND DEED.

IN WITNESS WHEREOF, I HAVE HEREUNTO SET MY HAND AND AFFIXED MY OFFICIAL SEAL AT MY OFFICE THE DAY AND YEAR LAST WRITTEN.

NOTARY PUBLIC IN AND FOR PLATTE COUNTY, MISSOURI

MY COMMISSION EXPIRES

CITY PLAN COMMISSION

APPROVED:

COUNCIL

THIS IS TO CERTIFY THAT THE WITHIN PLAT WAS DULY SUBMITTED TO AND APPROVED BY THE COUNCIL OF KANSAS CITY, MISSOURI, BY ORDINANCE NO. \_\_\_\_\_ DULY AUTHENTICATED AS PASSED THIS \_\_\_\_\_ DAY OF \_\_\_\_\_, 20\_\_\_\_.

PUBLIC WORKS DEPARTMENT

LOT 2 LINE TABLE		
Line #	Direction	Length
L1	S00°01'25"W	246.88'
L2	N00°10'42"E	246.96'
L3	N00°00'00"E	334.47'
L4	S00°00'00"E	334.47'
L5	N90°00'00"E	350.00'
L6	S00°00'00"E	700.00'
L7	N90°00'00"W	392.00'
L8	N00°00'00"E	700.00'
L9	N90°00'00"E	18.00'

LOT 2 CURVE TABLE					
Curve #	Length	Radius	Delta	CHD B	CHD L
C1	129.35'	188.00'	39°25'16"	S19°42'38"E	126.81'
C2	145.86'	212.00'	39°25'16"	N19°42'38"W	143.00'
C3	129.35'	188.00'	39°25'16"	N19°42'38"W	126.81'
C4	145.86'	212.00'	39°25'16"	S19°42'38"E	143.00'

WATER EASEMENT CURVE TABLE					
Curve #	Length	Radius	Delta	CHD B	CHD L
C5	314.13'	405.00'	44°26'24"	S27°08'19"E	306.31'
C6	400.19'	462.00'	49°37'49"	S24°32'37"E	387.80'

STORMWATER MANAGEMENT LINE TABLE		
Line #	Direction	Length
L10	N90°00'00"E	157.75'
L11	S31°03'09"E	274.69'
L12	S00°00'00"E	240.06'
L13	N90°00'00"W	299.44'
L14	N00°00'00"E	475.38'
L15	N90°00'00"W	107.86'
L16	N78°21'40"W	506.42'
L17	N16°56'43"W	199.10'
L18	N90°00'00"W	2879.54'
L19	N00°00'00"E	229.18'
L20	N90°00'00"E	2988.99'
L21	S51°26'41"E	706.45'
L22	S00°00'00"E	81.50'
L23	N89°43'21"W	176.05'
L24	N30°00'00"W	337.09'
L25	N51°23'20"E	109.51'
L26	S89°59'45"E	260.74'
L27	S00°16'18"W	361.10'

SEWER EASEMENT LINE TABLE		
Line #	Direction	Length
L28	N44°45'51"W	22.10'
L29	N45°31'06"E	231.37'
L30	N74°12'28"E	364.51'
L31	N90°00'00"E	651.04'
L32	S00°00'00"E	30.00'
L33	N90°00'00"E	646.88'
L34	N74°12'28"E	352.67'
L35	N45°31'06"E	228.39'
L36	N13°13'33"W	9.24'

WATER EASEMENT LINE TABLE		
Line #	Direction	Length
L37	S89°49'18"E	1361.99'
L38	S89°35'11"E	669.75'
L39	S89°35'11"E	1284.73'
L40	S89°37'57"E	1441.10'
L41	S89°40'04"E	594.27'
L42	S44°37'57"E	115.78'
L43	S00°16'18"W	1708.53'
L77	S67°18'34"E	65.30'

DRAINAGE EASEMENT LINE TABLE		
Line #	Direction	Length
L44	S89°49'18"E	39.84'
L45	S51°18'44"W	147.10'
L46	N38°41'16"W	25.00'
L47	N51°18'44"E	116.08'
L48	N89°37'57"W	17.22'
L49	S89°37'57"E	15.45'
L50	S28°12'21"E	47.55'
L51	S62°09'47"W	20.00'
L52	N28°12'21"W	58.31'
L53	S00°22'03"W	39.43'
L54	N89°37'57"W	20.00'
L55	N00°22'03"E	39.42'
L56	S89°40'04"E	20.00'
L57	N44°37'57"W	96.05'

DRAINAGE EASEMENT LINE TABLE		
Line #	Direction	Length
L58	S89°37'57"E	68.27'
L59	S00°40'12"W	67.92'
L60	N89°14'04"W	32.11'
L61	N00°45'56"E	20.00'
L62	S89°14'04"E	31.93'
L63	S00°16'18"W	20.00'
L64	N90°00'00"W	35.47'
L65	N00°00'00"E	20.00'
L66	N90°00'00"E	35.57'
L67	S00°16'18"W	20.00'
L68	N89°43'42"W	64.30'
L69	N00°16'18"E	40.00'
L70	S89°43'42"E	64.30'
L71	S00°16'18"W	40.00'

## LEGAL DESCRIPTION

ALL THAT PART OF THE NORTH ONE-HALF (1/2) OF SECTION 15, TOWNSHIP 52 NORTH, RANGE 33 WEST, LYING IN CLAY COUNTY, MISSOURI, AND ALL THAT PART OF THE FRACTIONAL NORTHWEST QUARTER OF SECTION 15, AND THE EAST 74 ACRES OF THE EAST ONE-HALF (1/2) OF THE NORTHEAST QUARTER OF SECTION 16, ALL IN TOWNSHIP 52 NORTH, RANGE 33 WEST, AS DESCRIBED AND RECORDED IN PLATTE COUNTY, MISSOURI, AS INSTRUMENT NUMBER 2020025260, IN BOOK 8743, PAGE 64, BEING MORE PARTICULARLY DESCRIBED AS FOLLOWS:

BEGINNING AT A 1/2" IRON BAR FOUND AT THE NORTH END OF A BOUNDARY LINE AGREEMENT DESCRIBED IN BOOK 291, PAGE 30, THENCE S 89° 49' 21" E, ALONG THE NORTH LINE OF THE NORTHEAST QUARTER OF SAID SECTION 16, A DISTANCE OF 1223.14 FEET TO A FOUND 1/2" IRON BAR WITH PLASTIC CAP STAMPED MO1303;  
 THENCE S 89° 49' 41" E, ALONG THE NORTH LINE OF SAID FRACTIONAL NORTHWEST QUARTER OF SECTION 15 IN SAID PLATTE COUNTY, A DISTANCE OF 490.26 FEET TO A FOUND 1/2" IRON BAR WITH PLASTIC CAP;  
 THENCE N 00° 40' 08" E, ALONG THE COUNTY LINE BETWEEN SAID CLAY COUNTY AND SAID PLATTE COUNTY, A DISTANCE OF 9.59 FEET TO A FOUND 1/2" IRON BAR WITH ALUMINUM CAP;  
 THENCE S 89° 35' 11" E, ALONG THE NORTH LINE OF SAID FRACTIONAL NORTHWEST QUARTER OF SECTION 15 IN SAID PLATTE COUNTY, A DISTANCE OF 1954.68 FEET TO A FOUND 1/2" REBAR;  
 THENCE S 89° 37' 57" E A DISTANCE OF 2114.31 FEET TO THE NEW WEST RIGHT OF WAY LINE FOR OUTER ROAD DESCRIBED IN MISSOURI DEPARTMENT OF TRANSPORTATION PLANS FOR JOB NUMBER 20-0268;  
 THENCE S 00° 40' 12" W, ALONG SAID WEST RIGHT OF WAY LINE, A DISTANCE OF 79.59 FEET TO THE SOUTHWEST CORNER OF THE RIGHT OF WAY DEDICATED FOR NW 128TH STREET;  
 THENCE S 00° 40' 12" W, CONTINUING ALONG SAID WEST RIGHT OF WAY LINE, A DISTANCE OF 67.92 FEET;  
 THENCE S 89° 23' 41" E, CONTINUING ALONG SAID WEST RIGHT OF WAY LINE, A DISTANCE OF 26.93 FEET;  
 THENCE CONTINUING ALONG SAID WEST RIGHT OF WAY LINE ON A CURVE TO THE LEFT AN ARC DISTANCE OF 331.37 FEET, SAID CURVE TO THE LEFT HAVING A RADIUS OF 380.00 FEET, A CHORD BEARING OF S 24° 22' 36" E AND A CHORD DISTANCE OF 320.97 FEET;  
 THENCE CONTINUING ALONG SAID WEST RIGHT OF WAY LINE ON A CURVE TO THE RIGHT AN ARC DISTANCE OF 421.85 FEET, SAID CURVE TO THE RIGHT HAVING A RADIUS OF 487.00 FEET, A CHORD BEARING OF S 24° 32' 37" E AND A CHORD DISTANCE OF 408.78 FEET;  
 THENCE S 00° 16' 18" W, CONTINUING ALONG SAID WEST RIGHT OF WAY LINE, A DISTANCE OF 1704.95 FEET TO A POINT ON THE NORTH RIGHT OF WAY LINE FOR NW 124TH STREET;  
 THENCE S 82° 07' 38" W, ALONG SAID NORTH RIGHT OF WAY LINE, A DISTANCE OF 266.85 FEET TO A FOUND RIGHT OF WAY MARKER ON THE WEST RIGHT OF WAY LINE FOR NW 124TH STREET;  
 THENCE S 00° 15' 26" W, ALONG SAID WEST RIGHT OF WAY LINE, A DISTANCE OF 75.02 FEET TO A FOUND 1/2" IRON BAR WITH PLASTIC CAP STAMPED "MO2004" ON THE SOUTH LINE OF THE NORTHEAST QUARTER OF SAID SECTION 15;  
 THENCE N 89° 43' 21" W, ALONG SAID SOUTH LINE, A DISTANCE OF 2183.48 FEET TO A FOUND 5/8" REBAR AT THE SOUTHWEST CORNER OF SAID NORTHEAST QUARTER;  
 THENCE N 89° 40' 36" W, ALONG THE SOUTH LINE OF THE FRACTIONAL NORTHWEST QUARTER OF SAID SECTION 15 IN SAID CLAY COUNTY, A DISTANCE OF 1956.62 FEET TO A 1/2" IRON BAR WITH "MEC" CAP AT THE SOUTHWEST CORNER OF SAID FRACTIONAL NORTHWEST QUARTER IN SAID CLAY COUNTY;  
 THENCE S 00° 21' 21" W, ALONG THE COUNTY LINE BETWEEN SAID CLAY COUNTY AND SAID PLATTE COUNTY, A DISTANCE OF 5.61 FEET TO A FOUND 1/2" IRON BAR WITH PLASTIC CAP STAMPED "LS1989" FOUND AT THE SOUTHEAST CORNER OF THE FRACTIONAL NORTHWEST QUARTER OF SAID SECTION 15 IN SAID PLATTE COUNTY;  
 THENCE N 89° 46' 12" W, ALONG THE SOUTH LINE OF SAID FRACTIONAL NORTHWEST QUARTER OF SAID SECTION 15, A DISTANCE OF 496.46 FEET TO A 5/8" REBAR FOUND AT THE SOUTHEAST CORNER OF THE NORTHEAST QUARTER OF SAID SECTION 16;  
 THENCE S 89° 37' 16" W, ALONG THE SOUTH LINE OF SAID NORTHEAST QUARTER, A DISTANCE OF 1222.85 FEET TO A 1/2" IRON BAR WITH PLASTIC CAP STAMPED "LS1989" FOUND AT THE SOUTH END OF SAID BOUNDARY LINE AGREEMENT;  
 THENCE N 00° 28' 45" E, ALONG SAID BOUNDARY LINE AGREEMENT, A DISTANCE OF 2571.80 FEET TO A 5/8" REBAR WITH ALUMINUM CAP SET AT THE SOUTHWEST CORNER OF THE RIGHT OF WAY DEDICATED FOR NW 128TH STREET;  
 THENCE N 00° 28' 45" E, CONTINUING ALONG SAID BOUNDARY LINE AGREEMENT, A DISTANCE OF 70.33 FEET TO THE POINT OF BEGINNING.

CONTAINING 15,934,167 SQUARE FEET OR 365.80 ACRES, MORE OR LESS.

## PLAT DEDICATION

THE UNDERSIGNED PROPRIETOR OF THE ABOVE DESCRIBED TRACT OF LAND HAS CAUSED THE SAME TO BE SUBDIVIDED IN THE MANNER SHOWN ON THE ACCOMPANYING PLAT, WHICH SUBDIVISION SHALL BE HEREAFTER KNOWN AS "PROJECT VELVET".

## EASEMENTS

AN EASEMENT IS HEREBY GRANTED TO PLATTE COUNTY, MISSOURI, AS TRUSTEE OF THE PUBLIC FOR LOCATING, CONSTRUCTING, OPERATING, AND MAINTAINING FACILITIES FOR WATER, GAS, ELECTRICITY, SEWAGE, TELEPHONE, CABLE TV AND SURFACE DRAINAGE, INCLUDING BUT NOT LIMITED TO UNDERGROUND PIPES AND CONDUITS, PAD MOUNTED TRANSFORMERS, SERVICE PEDESTALS, ANY OR ALL OF THEM UPON, OVER, UNDER AND ALONG THE STRIPS OF LAND DESIGNATED AS UTILITY EASEMENTS (UE), WHERE OTHERS ARE DESIGNATED FOR A PARTICULAR PURPOSE, THE USE THEREOF SHALL BE LIMITED TO THAT PURPOSE ONLY. ALL THE ABOVE EASEMENTS SHALL BE KEPT FREE FROM ANY AND ALL OBSTRUCTIONS WHICH WOULD INTERFERE WITH THE CONSTRUCTION OR RECONSTRUCTION, PROPER SAFE AND CONTINUOUS MAINTENANCE OF THE AFORESAID USES AND SPECIFICALLY THERE SHALL NOT BE BUILT THEREON OR THEREOVER ANY STRUCTURE (EXCEPT DRIVEWAYS, PAVED AREAS, GRASS, SHRUBS AND FENCES) NOR SHALL THERE BE ANY OBSTRUCTION TO INTERFERE WITH THE AGENTS AND EMPLOYEES OF PLATTE COUNTY, MISSOURI, AND ITS FRANCHISED UTILITIES FROM GOING UPON SAID EASEMENT AND AS MUCH OF THE ADJOINING LANDS AS MAY BE REASONABLY NECESSARY IN EXERCISING THE RIGHTS GRANTED BY THE EASEMENT. NO EXCAVATION OR FILL SHALL BE MADE OR OPERATION OF ANY KIND OR NATURE SHALL BE PERFORMED WHICH WILL REDUCE OR INCREASE THE EARTH COVERAGE OVER THE UTILITIES ABOVE STATED OR THE APPURTENANCES THERETO WITHOUT THE WRITTEN APPROVAL OF THE PLATTE COUNTY PLANNING AND ZONING DIRECTOR.

## STREETS

THE STREETS SHOWN ON THIS PLAT AND NOT HERETOFORE DEDICATED TO PUBLIC USE ARE HEREBY SO DEDICATED.

## CERTIFICATION

I, WILLIAM E. KNIGHT, A REGISTERED LAND SURVEYOR IN THE STATE OF MISSOURI CERTIFY THAT THIS SURVEY WAS PERFORMED BY ME OR UNDER MY DIRECT SUPERVISION, WAS MADE IN ACCORDANCE WITH THE MISSOURI MINIMUM STANDARDS FOR BOUNDARY SURVEYS AND IS TRUE AND CORRECT TO THE BEST OF MY KNOWLEDGE AND BELIEF.

*William E. Knight* 01/07/2022  
 WILLIAM E. KNIGHT PLS-2007000077 DATE

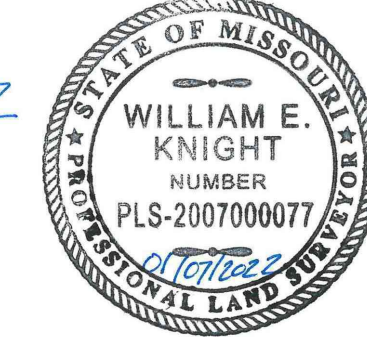

ACCESS EASEMENT LINE TABLE		
Line #	Direction	Length
L72	S00°00'08"E	60.47'
L73	S52°38'35"E	932.18'
L74	S00°00'00"E	395.88'

ROADWAY EASEMENT CURVE TABLE					
Curve #	Length	Radius	Delta	CHD B	CHD L
C7	30.87'	35.00'	50°32'34"	S49°01'38"W	29.88'
C8	171.11'	65.00'	150°49'49"	N80°49'45"W	125.81'

ROADWAY EASEMENT LINE TABLE		
Line #	Direction	Length
L75	S89°49'18"E	15.55'
L76	S89°49'18"E	146.77'

REVISION DESCRIPTION				
NO.	REVISION DESCRIPTION	BY	DATE	CHKD APPD
2	BOUNDARY, EASEMENTS, AND DETAILS	NWK	1/7/22	WEK
1	REQUESTS, DETAILS, AND ACCESS	TRZ	12/28/21	WEK

SHEET NO.: 1 OF 2  
 INFORMATION: COVER SHEET  
 2 OF 2 PROJECT VELVET PLAT

**WILSON & COMPANY**  
 900 East 101st Terrace, Suite 200  
 Kansas City, MO 64131  
 Phone: 816-701-3100  
 Fax: 816-942-3013

FINAL PLAT  
 MASTER PLANNED DEVELOPMENT (MPD)  
 PROJECT VELVET  
 128TH ST AND ARROWHEAD TRAFFICWAY  
 KANSAS CITY, MO 64165  
 CLAY/PLATTE COUNTY



# FINAL PLAT - PROJECT VELVET

LOCATED IN THE NORTH 1/2 OF SECTION 15, LYING IN CLAY COUNTY, MISSOURI, FRACTIONAL NW 1/4 OF SECTION 15, AND EAST 1/2 OF THE NE 1/4 OF SECTION 16, ALL IN TOWNSHIP 52 NORTH, RANGE 33 WEST OF THE FIFTH PRINCIPAL MERIDIAN IN KANSAS CITY, PLATTE COUNTY, MISSOURI

## CERTIFICATION

I, WILLIAM E. KNIGHT, A REGISTERED LAND SURVEYOR IN THE STATE OF MISSOURI CERTIFY THAT THIS SURVEY WAS PERFORMED BY ME OR UNDER MY DIRECT SUPERVISION, WAS MADE IN ACCORDANCE WITH THE MISSOURI MINIMUM STANDARDS FOR BOUNDARY SURVEYS AND IS TRUE AND CORRECT TO THE BEST OF MY KNOWLEDGE AND BELIEF.

*William E. Knight* 01/07/2022  
 WILLIAM E. KNIGHT PLS-2007000077 DATE

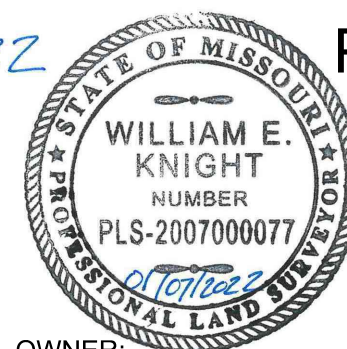

## LEGEND - SYMBOLS

- FOUND MONUMENT
  - ⊙ SET 5/8" REBAR WITH ALUMINUM CAP
- LEGEND - ABBREVIATIONS**
- BK. BOOK
  - COND. CONDEMNATION
  - FRACTIONAL
  - PG. PAGE
  - R/W RIGHT OF WAY
  - S.F. SQUARE FEET

## LEGEND - LINE STYLES

- PROPERTY LINE
- ADJACENT RIGHT OF WAY LINE
- ADJACENT PROPERTY LINE
- EASEMENT CENTERLINE
- BUILDING SETBACK LINE
- STORMWATER FACILITY
- ABANDONED EASEMENT
- ACCESS EASEMENT
- DRAINAGE EASEMENT
- EVERGY EASEMENT
- UTILITY EASEMENT
- WATER EASEMENT
- SEWER EASEMENT
- MODOT HIGHWAY PLANS RIGHT OF WAY
- FEMA FLOOD ZONE "AE"
- APPROXIMATE 100 YEAR FLOOD CONVEYANCE AS DETERMINED BY A PROFESSIONAL ENGINEER

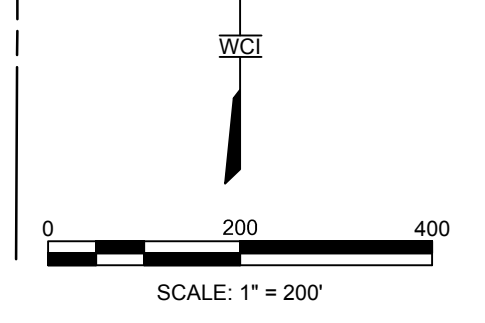
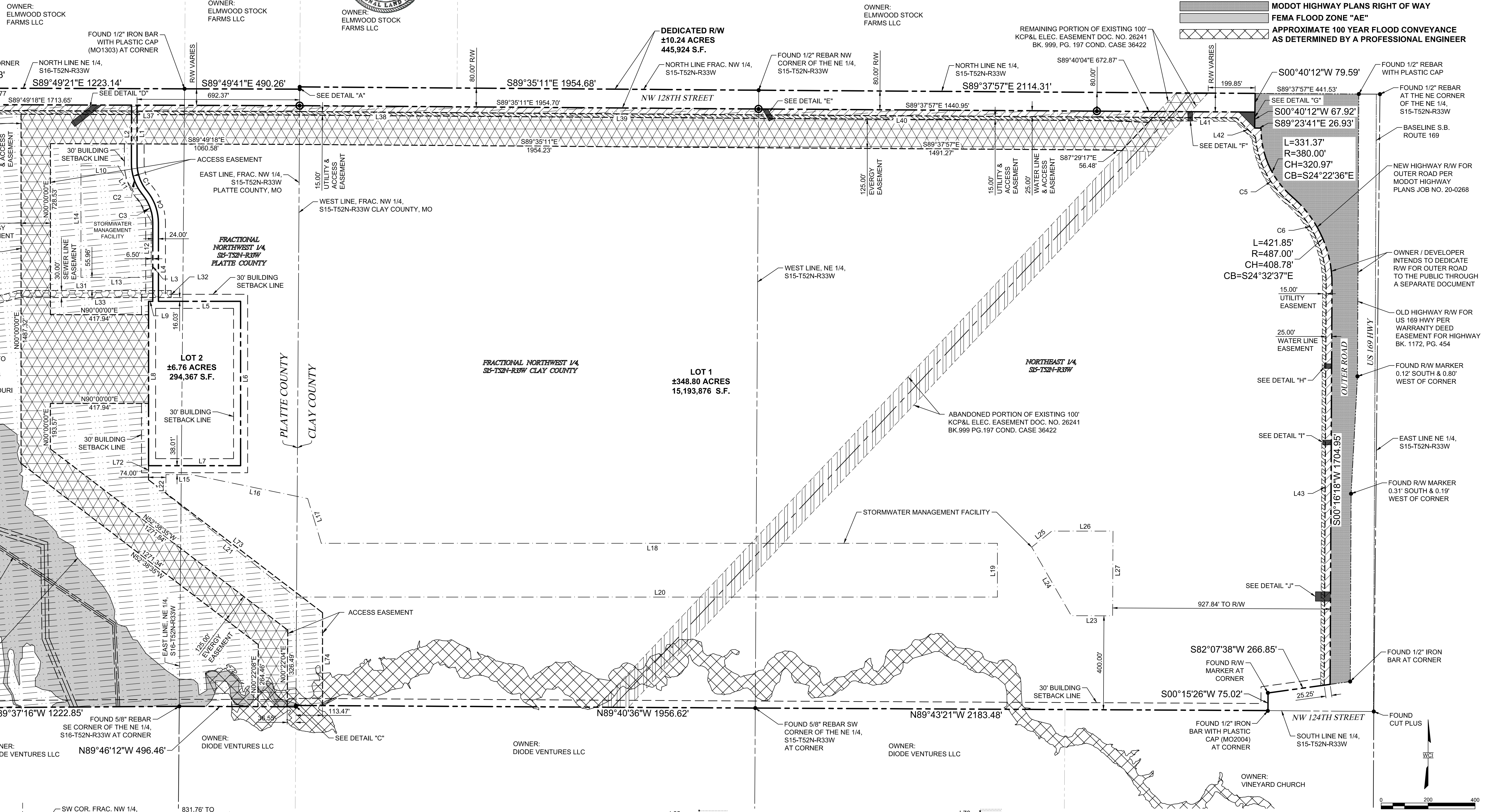
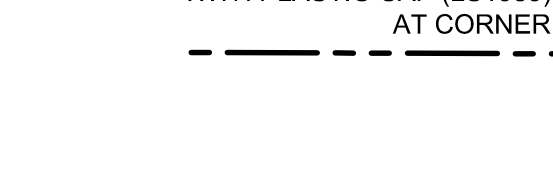
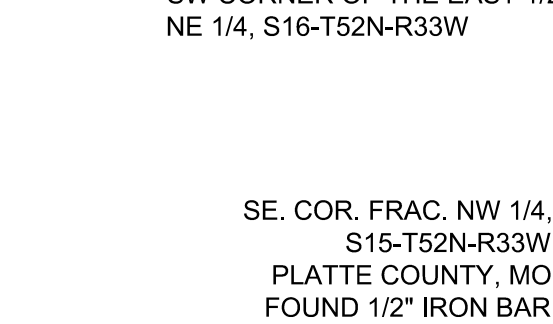
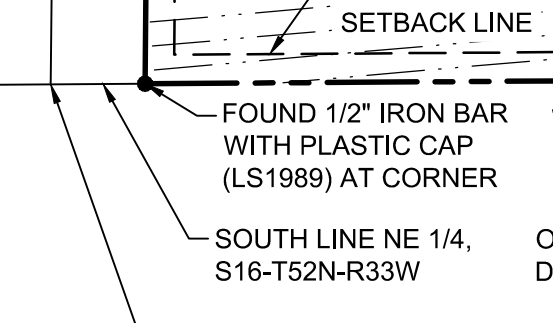
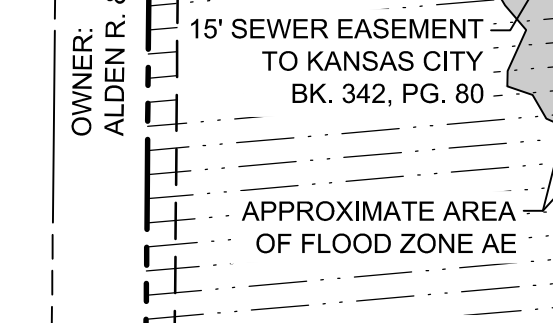
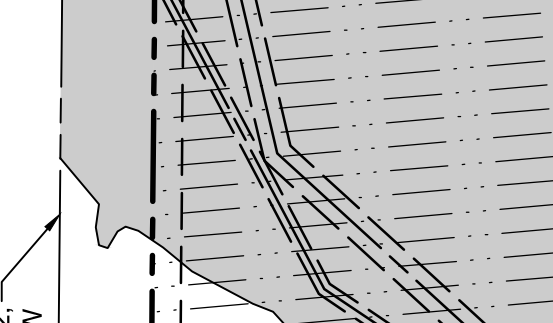
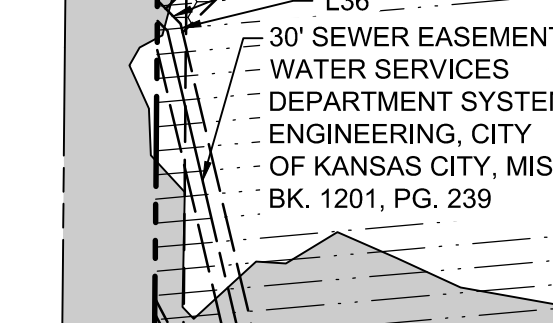
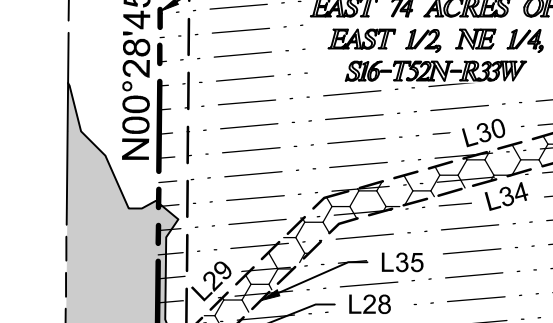
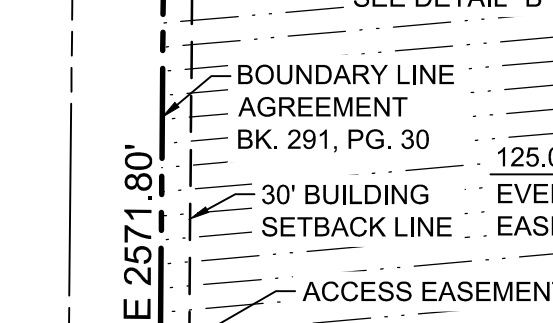
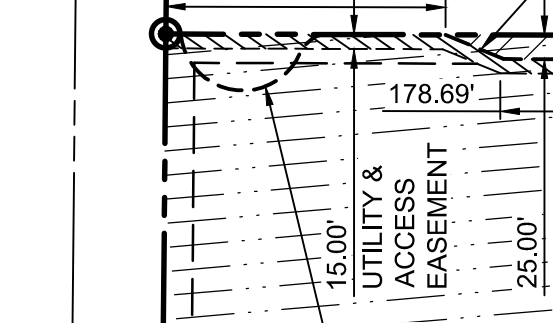
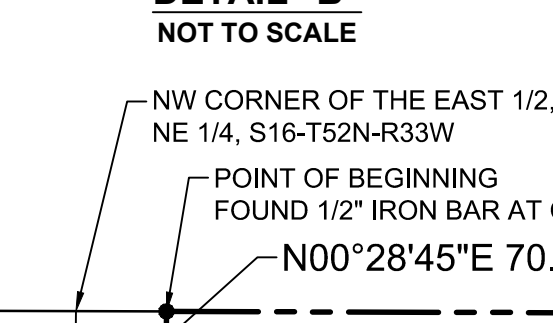
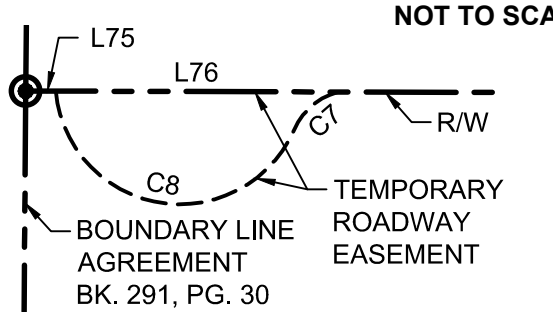
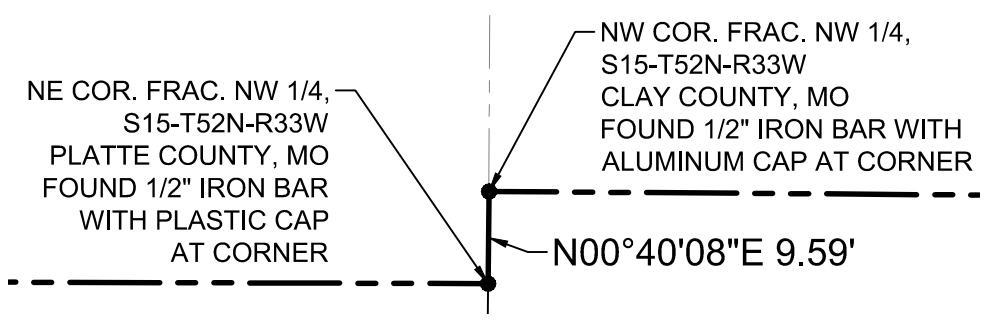

SHEET NO. 2 OF 2		SCALE: 1" = 200'		PROJECT NO. 21-300-248-00		DRAWN BY: NWK		DATE: 12/22/2021	
2 BOUNDARY, EASEMENTS, AND DETAILS		NWK 1/17/22		WEK 12/28/21		CHECKED BY: WEK		DATE: 12/22/2021	
1 REQUESTS, DETAILS, AND ACCESS		NWK 12/28/21		WEK 12/22/21		APPROVED BY:			

**WILSON & COMPANY**  
 400 East 101st Terrace, Suite 200  
 Kansas City, MO 64131  
 Phone: 816-701-3100  
 Fax: 816-942-3013

FINAL PLAT  
 MASTER PLANNED DEVELOPMENT (MPD)  
 PROJECT VELVET  
 128TH ST AND ARROWHEAD TRAFFICWAY  
 KANSAS CITY, MO 64165  
 CLAY/PLATTE COUNTY