

Prospect Ave	Connector	155th St.	280' South of M-150 Hwy.
Prospect Ave	Urban Mixed Use	40th St.	38th St.
Prospect Ave	Connector	30th St.	29th St.
Prospect Ave	Connector	46th St.	44th St.
Prospect Ave	Urban Mixed Use	7th St.	Independence Ave.
Prospect Ave	Industrial / Business Park	137' North of KCT RR	403' South of Truman Rd.
Prospect Ave	Connector	37th St.	35th Ter.
Prospect Ave	Boulevards	Independence Ave.	Reservoir Dr.
Prospect Ave	Connector	8th St.	7th St.
Prospect Ave	Industrial / Business Park	I-70 Hwy EB On-Ramp	I-70 Hwy
Prospect Ave	Urban Mixed Use	29th St.	29th St.
Prospect Ave	Connector	38th St.	37th St.
Prospect Ave	Urban Mixed Use	37th St.	25' North of 37th St.
Prairie View Rd	Suburban Commercial	Chatham Rd.	183' North of NW 62nd St.
Prairie View Rd	Connector	210' North of 77th Ter.	213' North of 81st St.
Prairie View Rd	Suburban Commercial	Barry Rd.	214' North of 81st St.
Prairie View Rd	Industrial / Business Park	Congress Ave.	Old Tiffany Springs Rd.
Prairie View Rd	Suburban Commercial	31' North of M-9 Hwy.	210' North of 77th Ter.
Prairie View Rd	Industrial / Business Park	KCMO City Limit	Bethel Ave.
Prairie View Rd	Connector	183' Northwest of NW 62nd St.	Northwood Rd.
Prairie View Rd	Suburban Commercial	70th St.	72nd St.
Prairie View Rd	Connector	70th St.	221' NW of Private Access Rd.
Prairie View Rd	Industrial / Business Park	Tiffany Springs Pkwy.	86' North West of Vienna Rd.
Prairie View Rd	Industrial	112th St.	Vienna Rd.
Pleasant Valley Rd	Connector	Searcy Creek Pkwy	Shoal Creek Pkwy.
Pleasant Valley Rd	Connector	Gladstone City Limit	Brighton Ave.
Pleasant Valley Rd	Connector	Searcy Creek Pkwy.	Pleasant Valley City Limit
Pleasant Valley Rd	Parkways	Brighton Ave.	Searcy Creek Pkwy
Platte Purchase Dr	Connector	Ames Ave.	917' North of 71st St.
Platte Purchase Dr	Connector	917' North of 71st St.	75th St.
Platte Purchase Dr	Connector	68th St.	Agnes Ave.
Pershing Rd	Boulevards	Broadway St.	Gillham Rd.
Penn Valley Dr	Parkways	30th St.	West Pennway St.

Paseo St	Boulevards	Paseo Blvd.	Vine St.
Paseo Blvd	Boulevards	63rd St.	Dr. Martin Luther King Jr. Blvd.
Paseo Blvd	Boulevards	63rd St.	Meyer Blvd.
Paseo Blvd	Connector	85th St.	82nd St.
Paseo Blvd	Urban Mixed Use	82nd St.	79th St.
Paseo Blvd	Boulevards	Emanuel Cleaver II Blvd.	45th St.
Paseo Blvd	Boulevards	18th St.	Lexington Ave.
Paseo Blvd	Boulevards	79th St.	Paseo Blvd.
Paseo Blvd	Boulevards	Dr. Martin Luther King Jr. Blvd.	Emanuel Cleaver II Blvd.
Paseo Blvd	Boulevards	45th St.	31st St.
Paseo Blvd	Boulevards	31st St.	18th St.
Paseo Blvd	Boulevards	69th St.	Meyer Blvd
Parvin Rd	Suburban Commercial	Corrington Ave.	Randolph Rd.
Parvin Rd	Boulevards	Holmes St.	Davidson Rd.
Parvin Rd	Suburban Commercial	Brighton Ave.	Hardesty Ave.
Parvin Rd	Suburban Commercial	Chouteau Pkwy	Jackson Ave.
Parvin Rd	Connector	Jackson Ave.	Brighton Ave.
Parvin Rd	Connector	Randolph Rd.	156' East of I-435 Hwy Off-Ramp
Parvin Rd	Boulevards	Davidson Rd.	Cleveland Ave.
Parvin Rd	Connector	Hardesty Ave.	213' East of Winchester Ave.
Parvin Rd	Boulevards	Cleveland Ave.	Chouteau Pkwy.
Parvin Rd	Industrial / Business Park	97' West of Randolph Rd.	Birmingham City Limit
Parvin Rd	Connector	213' West of Winchester Ave.	Corrington Ave.
Paris St	Connector	Mexico City Ave.	Cookingham Drive On-Ramp
Oldham Rd	Parkways	Lakeside Dr.	Oakwood Dr.
Oldham Rd	Parkways	87th St.	Blue River Rd.
Old Stagecoach Rd	Connector	Belton Ave.	Line Creek Pkwy.
Oak St	Downtown Core	77' North of 22nd St.	Truman Rd.
Oak St	Downtown Core	13th St.	11th St.
Oak St	Downtown Core	8th St.	Oak Trfy On-Ramp
Oak St	Downtown Core	11th St.	10th St.
Oak St	Downtown Core	10th St.	9th St.
Oak St	Downtown Core	9th St.	8th St.

Oak St	Downtown Core	Truman Rd.	13th St.
NW Tiffany Springs Rd	Connector	Green Hills Rd.	Belton Ave.
NW Tiffany Springs Pkwy	Parkways	Ambassador Dr.	Green Hills Rd.
NW Tiffany Springs Pkwy	Parkways	Platte Purchase Dr.	US 169 Hwy.
NW 96th St	Industrial / Business Park	KCMO City Limit	Tiffany Springs Pkwy.
NW 79th St	Connector	Montclair Ave.	Green Hills Rd.
NW 72nd St	Connector	Tomahawk Ln.	Overland Dr.
NW 72nd St	Suburban Commercial	Roanridge Rd.	59' East of Tomahawk Ln.
NW 72nd St	Connector	Prairie View Rd.	Roanridge Rd.
NW 68th St	Connector	Coventry Ave.	US-169 NB On-Ramp
NW 68th St	Suburban Commercial	US-169 Hwy Ramp	Gladstone City Limit
NW 68th St	Connector	Robinhood Ln.	Waukomis Dr.
NW 68th St	Parkways	Line Creek Pkwy.	Coventry Ave.
NW 64th St	Connector	I-29 Hwy On-Ramp	64th St.
NW 64th St	Thoroughfare	Cosby Ave.	I-29 Hwy On-Ramp
NW 64th St	Thoroughfare	Klamm Rd.	Cosby Ave.
NW 56th St	Boulevards	Waukomis Dr.	Liberty Ave.
NW 128th St	Connector	Interurban Rd.	Skyview Ave.
NW 128th St	Connector	Skyview Ave.	Robinhood Ln.
NW 112th St.	Industrial / Business Park	Congress Ave.	NW 108th St.
NW 112th St	Industrial / Business Park	I-29 Hwy SB On-Ramp	Congress Ave.
NW 112th St	Connector	Prarie View Rd.	I-29 Hwy Off-Ramp
NW 100th St	Parkways	Green Hills Rd.	Platte Purchase Dr.
Northwood Rd	Suburban Commercial	297' South of 58th Ter.	Prairie View Rd.
Northwood Rd	Connector	52nd St.	297' South of 58th Ter.
Norfleet Rd.	Industrial	40th St.	M-210 Hwy.
Noland Rd	Parkways	Brickyard Rd.	Little Blue Rd.
Noland Rd	Thoroughfare	Little Blue Rd.	US-40 Hwy.
NE 96th St	Boulevards	West Fork Shoal Creek	Maplewoods Pkwy.
NE 96th St	Connector	Indiana Ave.	Lawn Ave.
NE 80th St	Parkways	M-1 Hwy.	Spruce Ave.
NE 76th St	Connector	Shoal Creek Pkwy.	Flintlock Rd.
NE 76th St	Connector	Brighton Ave.	East Fork Shoal Creek

NE 76th St	Connector	East Fork Shoal Creek	Shoal Creek Pkwy.
NE 72nd St	Connector	Gladstone City Limit	Brighton Ave.
NE 48th St	Parkways	Brighton Ave.	Searcy Creek Pkwy
NE 48th St	Connector	Randolph Rd.	Worlds of Fun Dr.
NE 48th St	Connector	Searcy Creek Pkwy	Randolph Rd.
NE 42nd St	Boulevards	Oak Trfy	Holmes St.
NE 108th St	Connector	Hardesty Ave.	Cookingham Dr.
N Woodland Av	Connector	EB I-435 Hwy On-Ramp	126th St.
N Woodland Av	Connector	111th Ter.	Cookingham Dr.
N Woodland Av	Suburban Commercial	Cookingham Dr.	I-435 Hwy On-Ramp
N Winah Ave	Industrial / Business Park	128th St.	Everton Ave.
N Winan Av	Industrial / Business Park	132nd St.	M-92 Hwy.
N Van Brunt Ave	Boulevards	12th St.	Gladstone Blvd.
N Platte Purchase Dr	Suburban Commercial	Barry Rd.	M-152 Hwy On-Ramp
N Platte Purchase Dr	Connector	Tiffany Springs Rd.	3744' North of 108th St.
N Platte Purchase Dr	Connector	M-150 Hwy On-Ramp	Pleasant Valley Rd.
N Platte Purchase Dr	Connector	76th St.	Barry Rd.
N Platte Purchase Dr	Suburban Commercial	M-152 Hwy On-Ramp	Tiffany Springs Rd.
N Platte Purchase Dr	Connector	N. Platte Purchase Dr.	Cookingham Dr.
N Oak Trfy	Suburban Commercial	126' South of M-152 Hwy On-Ramp	95th Ter.
N Oak Trfy	Connector	259' North of 111th St.	Cookingham Dr.
N Oak Trfy	Suburban Commercial	111th St.	260' North of 111th St.
N Oak Trfy	Suburban Commercial	65' North of I-29 Hwy.	Access Road Apts
N Oak Trfy	Suburban Commercial	734' South of 79th Ter.	61' North of 86th Ter.
N Oak Trfy	Suburban Commercial	19' South of 107th St.	25' North of 109th Ter.
N Oak Trfy	Suburban Commercial	95th Ter.	96th St.
N Oak Trfy	Connector	54th Ter.	344' North of 50th Ter.
N Oak Trfy	Suburban Commercial	154' South of Hill St.	43rd St.
N Oak Trfy	Connector	44th St.	I-29 Hwy.
N Oak Trfy	No typology	24' South of EB I-29 Hwy.	36' North of WB I-29 Hwy.
N Oak Trfy	Connector	109th Ter.	111th St.
N Oak Trfy	Connector	97th St.	107th St.
N Oak Trfy	Suburban Commercial	West Fork Shoal Creek	117' South of M-152 Hwy On-Ramp

N Oak Tfwy	Connector	61' North of 86th Ter.	West Fork Shoal Creek
N Oak Tfwy	Neighborhood	33' South of 44th St.	40' North of 44th St.
N Oak Tfwy	Suburban Commercial	54th Ter.	Englewood Rd.
N Oak Tfwy	Connector	446' South of 50th Ter.	50th Ter.
N Oak Tfwy	Connector	43rd St.	43rd Ter.
N Oak Tfwy	Connector	North Kansas City City Limit	154' South of Hill St.
N Oak Tfwy	Suburban Commercial	96th St.	9' North of 97th St.
N Oak Tfwy	Suburban Commercial	50th Ter.	17' South of Commercial Access Rd.
N Oak Tfwy	Suburban Commercial	43rd Ter.	315' North of 43rd Ter.
N Indiana Ave	Connector	Barry Rd.	100th St.
N Indiana Av	Suburban Commercial	M-152 Hwy Off-Ramp	Barry Rd.
N Hampton Rd	Connector	92' South of Barry Rd.	Tiffany Park Rd.
N Green Hills Rd	Suburban Commercial	90th St.	Tiffany Springs Rd.
N Green Hills Rd	Suburban Commercial	167' North of Line Creek Dr.	M-152 Hwy On-Ramp
N Green Hills Rd	Connector	Robinhood Ln.	167' North of Line Creek Dr.
N Green Hills Rd	Connector	M-152 Hwy On-Ramp	90th St.
N Green Hills Rd	Connector	Tiffany Springs Rd.	108th St.
N Congress Av	Industrial / Business Park	Ambassador Dr.	Cookingham Dr.
N Congress Av	Connector	Barry Rd.	Donovan Dr.
N Congress Av	Industrial / Business Park	Old Tiffany Springs Rd.	Tiffany Springs Pkwy.
N Congress Av	Suburban Commercial	Donovan Dr.	Old Tiffany Springs Rd.
N Childress Av	Connector	Old Tiffany Springs Rd.	KCMO City Limit
N Brighton Ave	Connector	Barry Rd.	96th St.
N Brighton Ave	Parkways	48th St.	Pleasant Valley Rd.
N Brighton Ave	Suburban Commercial	Parvin Rd.	24' North of 42nd St.
N Brighton Ave	Connector	36th St.	Parvin Rd.
N Brighton Ave	Suburban Commercial	44th Ter.	46th Ter.
N Brighton Ave	Suburban Commercial	M-152 Hwy.	350' North of M-152 Hwy On-Ramp
N Brighton Ave	Connector	M-152 Hwy On-Ramp	M-152 Hwy.
N Brighton Ave	Connector	Pleasant Valley Rd.	80th St.
N Brighton Ave	Suburban Commercial	Soccer Dr.	M-152 Hwy Off-Ramp
N Brighton Ave	Connector	Birmingham Rd.	34th Ter.
N Brighton Ave	Suburban Commercial	438' South of Barry Rd.	Barry Rd.

N Brighton Ave	Industrial / Business Park	Brighton Ave.	36th St.
N Brighton Ave	Connector	46th Ter.	48th St.
N Brighton Ave	Connector	42nd St.	44th Ter.
N Bethel Ave	Industrial / Business Park	Prairie View Rd.	M-92 Hwy.
N Arlington Av	Industrial / Business Park	M-210 Hwy.	Parvin Rd.
N Amity Av	Connector	Barry Rd.	Old Tiffany Springs Rd.
N Amity Av	Industrial / Business Park	Old Tiffany Springs Rd.	Tiffany Springs Pkwy.
N 72nd St	Connector	M-9 Hwy	Prairie View Rd.
N 108th St	Industrial / Business Park	NW 112th St.	122' East of Second Creek
N 108th St	Parkways	Robinhood Ln.	Mulberry St.
N 108th St	Connector	122' East Second Creek	Robinhood Ln.
Mo 350/Blue Pkwy	Thoroughfare	55th St.	M-350 Hwy
Mo 350/Blue Pkwy	Thoroughfare	55th St.	<Null>
Mill Creek Pkwy	Boulevards	Ward Pkwy.	43rd St.
Meyer Blvd	Boulevards	Paseo Blvd. Soutbound	Bushman Dr.
Meyer Blvd	Boulevards	Wornall Rd.	Paseo Blvd.
Meyer Blvd	Parkways	Paseo	Starlight Rd.
Meyer Blvd	Parkways	Askew Ave.	Starlight Rd.
Meyer Blvd	Parkways	East Meyer Blvd. Roundabout	East Meyer Blvd. Roundabout
Meyer Blvd	Boulevards	Paseo Blvd.	Paseo Blvd.
Meyer Blvd	Boulevards	Ward Pkwy.	Wornall Rd.
Mexico City Ave	Industrial / Business Park	I-29 Hwy	132nd St.
Mexico City Ave	Connector	Paris St.	I-29 Hwy.
Mexico City Ave	Thoroughfare	136th St.	M-92 Hwy.
Mexico City Ave	Thoroughfare	136th St.	M-92 Hwy.
Mersington Ave	Connector	343' North of I-435 Hwy.	KCMO City Limit
Mersington Ave	Connector	108th St.	Cookingham Dr.
Mersington Ave	Connector	343' North of I-435 Hwy.	Cookingham Dr.
Mary Lou Williams Ln	Urban Mixed Use	Paseo Blvd.	Woodland Ave.
Martha Truman Rd	Connector	Blue Ridge Rd.	Grandview City Limit
Martha Truman Rd	Connector	Wornall Rd.	143' East of McGee St.
Martha Truman Rd	Connector	143' East of McGee St.	Holmes Rd.
Martha Truman Rd	Connector	Holmes Rd.	Blue Ridge Rd.

Martha Truman Rd	Connector	Grandview City Limit	563' East of Grandview City Limit
Marion Park Dr	Suburban Commercial	Hickman Mills Dr.	Bannister Rd.
Maplewoods Pkwy	Parkways	Barry Rd.	Brooklyn Ave.
Maplewoods Pkwy	Parkways	Shoal Creek Pkwy.	Spruce Ave.
Maplewoods Pkwy	Parkways	Agnes Ave.	Barry Rd.
Maplewoods Pkwy	Parkways	Spruce Ave.	80th St.
Maplewoods Pkwy	Parkways	Agnes Ave.	M-1 Hwy.
Maple Blvd	Boulevards	Independence Ave.	340' West of Garfield Ave.
Manheim Rd	Boulevards	Holmes St.	Troost Ave.
Manheim Rd	Boulevards	Troost Ave.	39th St.
Manchester Trfy	Industrial / Business Park	Manchester Trfy.	Truman Rd.
Manchester Trfy	Industrial / Business Park	Stadium Dr.	33rd St.
Manchester Trfy	Suburban Commercial	Winchester Ave.	187' North of 39th St.
Main St	Urban Mixed Use	46th St.	31st St.
Main St	Downtown Core	31st St.	730' North of Pershing Rd.
Main St	Downtown Core	16th St.	9th St.
Main St	Downtown Core	9th St.	7th St.
Main St	Downtown Core	730' North of Pershing Rd.	19th St.
Main St	Downtown Core	19th St.	16th St.
Main St	Connector	Emanuel Cleaver II Blvd.	46th St.
Madison Ave	Connector	47th St.	43rd St.
Longview Rd	Suburban Commercial	Bennington Ave.	Winchester Ave.
Longview Rd	Connector	Hickman Mills Dr.	Bennington Ave.
Longview Rd	Suburban Commercial	Nordy Rd.	Hickman Mills Dr.
Longview Rd	Connector	Grandview Rd.	Norby Rd.
Longview Rd	Connector	Winchester Ave.	Greenwood Rd.
Locust St	Downtown Core	Admiral Blvd.	Oak Trfy Off-Ramp
Little Blue Rd	Connector	Raytown City Limit	Noland Rd.
Little Blue Rd	Boulevards	300' East of Breckenridge Ave.	Lee's Summit Rd.
Little Blue Rd	Connector	Noland Rd.	Lee's Summit Rd.
Linwood Blvd	Boulevards	Broadway Blvd.	Van Brunt Blvd.
Line Creek Pkwy	Parkways	Barry Rd.	Tiffany Springs Rd.
Line Creek Pkwy	Parkways	NW 100th St.	N 108th St.

Line Creek Pkwy	Parkways	Tiffany Springs Rd.	97th St.
Line Creek Pkwy	Parkways	76th St.	Barry Rd.
Line Creek Pkwy	Parkways	NW 68th St.	Private School Dr.
Line Creek Pkwy	Parkways	97th St.	100th St.
Lee's Summit Rd	Connector	Gregory Blvd.	248' South of 48th Ter.
Lee's Summit Rd	Suburban Commercial	83rd St.	Gregory Blvd.
Lee's Summit Rd	Connector	Lee's Summit City Limit	83rd St.
Leeds Trfy	Connector	Chelsea Dr.	Emanuel Cleaver II Blvd.
Leeds Trfy	Industrial / Business Park	Emanuel Cleaver II Blvd.	Stadium Dr.
Karnes	Boulevards	Wyoming St.	31st St.
James St	Connector	KCMO City Limit	Genessee St.
James A Reed Rd	Connector	360' North of Bannister Rd.	Raytown City Limit
James A Reed Rd	Connector	95' North of I-470 Hwy.	197' South of 96th Ter.
James A Reed Rd	Suburban Commercial	197' South of 96th Ter.	360' North of Bannister Rd.
James A Reed Rd	Connector	Blue Ridge Blvd.	63rd St.
James A Reed Rd	Parkways	107th St.	I-470 Hwy
James A Reed Rd	Connector	Raytown City Limit	87th St.
Jackson Ave	Connector	Linwood Blvd.	Truman Rd.
Interurban Rd	Connector	Ferrelview Ave.	NW 128th St.
Interurban Rd	Industrial / Business Park	128th St.	KCMO City Limit
Indiana Ave	Connector	100th St.	Staley Rd.
Independence Ave	Downtown Core	Charlotte St.	I-35/I-29 Hwy
Independence Ave	Urban Mixed Use	Benton Blvd.	KCT Railroad
Independence Ave	Boulevards	Paseo Blvd.	Benton Blvd.
Independence Ave	Thoroughfare	I-35/I-29 Hwy	Paseo
Independence Ave	Thoroughfare	KCT RR	Winchester Ave.
Hwy 9	Downtown Core	Oak Trfy. Off-Ramp	5th St.
Hwy 9	Downtown Core	5th St.	Oak Trfy On-Ramp
Home Ave	Connector	112th St.	116th St.
Home Ave	Connector	104th St.	112th St.
Holmes St	Boulevards	78th St.	Rockhill Rd.
Holmes St	Connector	Woodbridge Ln.	552' North of Minor Dr.
Holmes St	Suburban Commercial	Dyke Branch Creek	93rd Ter

Holmes St	Suburban Commercial	105th St.	I-435 Hwy Off-Ramp	I-435 Hwy Off-Ramp
Holmes St	Suburban Commercial	I-435 Hwy Off-Ramp	Cherry St.	Cherry St.
Holmes St	Connector	85th St.	78th St.	78th St.
Holmes St	Connector	93rd Ter.	314' South of 85th St.	314' South of 85th St.
Holmes St	Connector	110th Ter.	105th St.	105th St.
Holmes St	Connector	Kenneth Rd.	Big Blue River	Big Blue River
Holmes St	Suburban Commercial	155th St.	Kenneth Rd.	Kenneth Rd.
Holmes St	Suburban Commercial	Blue Ridge Blvd.	Woodbridge Ln.	Woodbridge Ln.
Holmes St	Suburban Commercial	135th St.	Blue Ridge Blvd.	Blue Ridge Blvd.
Holmes St	Suburban Commercial	Access Rd.	110th Ter.	110th Ter.
Holmes St	Connector	31st St.	127' South of 21st St.	127' South of 21st St.
Holmes St	Suburban Commercial	Indian Creek	98th St.	98th St.
Holmes St	Downtown Core	130' South of 21st St.	Truman Rd.	Truman Rd.
Holmes St	Downtown Core	14th St.	13th St.	13th St.
Holmes St	Downtown Core	13th St.	12th St.	12th St.
Holmes St	Downtown Core	11th St.	9th St.	9th St.
Holmes St	Suburban Commercial	Big Blue River	135th St.	135th St.
Holmes St	Connector	98th St.	Dyke Branch Creek	Dyke Branch Creek
Holmes St	Connector	Cherry St.	Indian Creek	Indian Creek
Holmes St	Downtown Core	Truman Rd.	14th St.	14th St.
Holmes St	Suburban Commercial	Access Road Apts.	85th St.	85th St.
Hillcrest Rd.	Suburban Commercial	109th Ter.	Bannister Rd.	Bannister Rd.
Hillcrest Rd	Suburban Commercial	Hickman Mills Dr.	109th Ter	109th Ter
Highland	Boulevards	7th St.	Independence Ave.	Independence Ave.
High Grove Rd	Connector	Grandview City Limit	Raytown Rd.	Raytown Rd.
Hickory St	Downtown Core	Forester Rd.	9th St.	9th St.
Hickman Mills Dr	Industrial / Business Park	UP RR	US-71 Hwy	US-71 Hwy
Hickman Mills Dr	Suburban Commercial	US 71 Hwy Off-Ramp	Red Bridge Rd.	Red Bridge Rd.
Hickman Mills Dr	Suburban Commercial	Access Road Apt.	Marion Park Dr.	Marion Park Dr.
Hickman Mills Dr	Urban Mixed Use	UP Railroad	Prospect Ave.	Prospect Ave.
Hickman Mills Dr	Connector	770' North of 109th Ter.	408' North West of I-470 Hwy Off-Ramp	408' North West of I-470 Hwy Off-Ramp
Harrison Pkwy	Parkways	Gillham Rd.	Harrison Pkwy.	Harrison Pkwy.
Harrison Pkwy	Parkways	Gillham Rd.	37th St.	37th St.

Harrison Blvd	Boulevards	39th St.	Armour Blvd.
Harrison Blvd	Parkways	37th Ter.	Harrison Blvd.
Harrison	Boulevards	Emanuel Cleaver II Blvd.	Brush Creek Blvd.
Harrison	Boulevards	Gillham	Harrison St.
Hardesty Ave	Connector	Hardesty Ave Crovr.	11th St.
Hardesty Ave	Boulevards	Bonita Ave.	Van Brunt Blvd.
Hardesty Ave	Industrial	21' South of 11th St.	Independence Ave.
Hardesty Ave	Connector	Pine Grove Dr.	108th St.
Hardesty Ave	Connector	Pine Grove Dr.	Staley Rd.
Gregory Blvd	Boulevards	Prospect Ave.	Oldham Rd.
Gregory Blvd	Boulevards	Ward Pkwy.	Prospect Ave.
Gregory Blvd	Boulevards	Gregory Blvd.	Blue Ridge Blvd.
Grandview Rd	Industrial / Business Park	Grandview City Limit	Longview Rd.
Grandview Rd	Connector	414' North of 114th St.	159' North of 112th Ter.
Grandview Rd	Suburban Commercial	86' South of 112th St.	Red Bridge Rd.
Grand Blvd	Boulevards	6th St.	20th St.
Grand Blvd	Boulevards	6th St.	Independence Ave.
Grand Blvd	Boulevards	20th St.	Main St.
Grand Blvd	Boulevards	3rd St.	Independence Ave.
Gower Rd	Connector	64th St.	NW 68th St.
Gladstone Blvd	Boulevards	Belmont Blvd.	St. John Ave.
Gillham Rd	Parkways	W. Gillham Rd.	Armour Blvd.
Gillham Rd	Boulevards	31st St.	22nd St.
Gillham Rd	Parkways	146' South of Armour Blvd.	Armour Blvd.
Gillham Rd	Parkways	Gillham Rd.	210' South of Armour Blvd.
Gillham Rd	Parkways	32' North of 39th St.	146' South of Armour Blvd.
Gillham Plz	Boulevards	Armour Rd.	31st St.
Gillham	Boulevards	Brush Creek Blvd.	Gillham Rd.
Gillham	Parkways	Harrison St.	41st St.
Gillham	Parkways	NB Crossover	NB Crossover
Gillham	Parkways	SB Crossover	SB Crossover
Genessee St	Connector	American Royal Dr.	Wyoming St.
Genessee St	Connector	James St. Via.	American Royal Dr.

Front St.	Thoroughfare	Century Ave.	Independence City Limit
Front St	Thoroughfare	Chouteau Trfy.	Century Ave.
Front St	Thoroughfare	Casino Access Rd.	Chouteau Trfy.
Front St	Thoroughfare	I-35/I-29 Hwy On-Ramp	Casino Access Rd.
Front St	Boulevards	Lydia Ave.	I-35/I-29
Forester Rd	Connector	181' East of Santa Fe St.	Beadsley Rd.
Forester Rd	Downtown Core	Hickory St.	990' East of Hickory St.
Food Ln	Connector	City Limit (Grandview)	Longview Rd.
Flintlock Rd	Suburban Commercial	85' South of 79th St.	Shoal Creek Valley Dr.
Flintlock Rd	Connector	Shoal Creek Valley Dr.	96th St.
Everton Ave.	Industrial / Business Park	104th St.	Prairie View Rd.
Everton Ave	Industrial / Business Park	104th St.	Prairie View Rd.
Englewood Rd	Boulevards	Summit St.	Access Rd.
Englewood Rd	Boulevards	Liberty Ave.	Summit St.
Emanuel Cleaver II Blvd	Boulevards	Rockhill Rd.	Benton Blvd.
Emanuel Cleaver II Blvd	Parkways	Benton Blvd.	31st St.
Emanuel Cleaver II Blvd	Boulevards	Brookside Blvd.	Oak St.
Emanuel Cleaver II Blvd	Boulevards	Oak St.	Rockhill Rd.
Ella Fitzgerald	Connector	Paseo	Woodland Ave.
Eastwood Trfy	Connector	Dr. Martin Luther King Jr. Blvd.	SB I-435 Hwy On-Ramp
Eastwood Trfy	Connector	I-435 Hwy On-Ramp	Palmer Dr.
Eastwood Trfy	Connector	SB I-435 Hwy On-Ramp	NB I-435 Hwy On-Ramp
Eastern Ave	Thoroughfare	112th Ter.	KCMO City Limit
Eastern Ave	Connector	Shoal Creek Pkwy.	112th Ter.
Dr. Martin Luther King Jr Blvd	Boulevards	Mill Creek Pkwy.	Paseo Blvd.
Dr. Martin Luther King Jr Blvd	Parkways	Paseo	Elmwood Ave.
Dr. Martin Luther King Jr Blvd	Thoroughfare	Elmwood Ave.	55th St.
Delaware St	Downtown Core	7th St.	Independence Ave.
Coventry Ave	Parkways	68th St.	76th St.
Cookingham Drive On Ramp	Connector	Bern St.	Cookingham Dr.
Cookingham Drive On Ramp	Connector	Bern St.	Cookingham Dr.
Cookingham Drive On Ramp	Connector	Paris St.	Cookingham Dr.
Cookingham Dr Off Ramp	Connector	Cookingham Dr.	Bern St.

Cookingham Dr Off Ramp	Connector	Cookingham Dr.	Cookingham Dr.	Bern St.
Cookingham Dr Off Ramp	Connector	Cookinham Dr.	Cookinham Dr.	Paris St.
Cookingham Dr	Connector	Ferrelview City Limit	Ferrelview City Limit	Second Creek
Cookingham Dr	Connector	I-29 Hwy On-Ramp	I-29 Hwy On-Ramp	I-435 Hwy On-Ramp
Cookingham Dr	Connector	Paris St.	Paris St.	Prairie View Rd.
Cookingham Dr	Connector	1209' West of Agnes Ave.	1209' West of Agnes Ave.	I-435 Hwy On-Ramp
Cookingham Dr	Suburban Commercial	1708' West of Outer Rd.	1708' West of Outer Rd.	393' West of Madison Ave.
Cookingham Dr	Suburban Commercial	US 169 Ramp	US 169 Ramp	Main St.
Cookingham Dr	Suburban Commercial	Woodland Ave.	Woodland Ave.	1208' East of Agnes Ave.
Cookingham Dr	Connector	Main St.	Main St.	Woodland Ave.
Cookingham Dr	Thoroughfare	Sherman Rd.	Sherman Rd.	Flintlock Rd.
Cookingham Dr	Thoroughfare	I-435 Hwy On-Ramp	I-435 Hwy On-Ramp	Sherman Rd.
Cookingham Dr	Thoroughfare	Flintlock Rd.	Flintlock Rd.	Liberty City Limit
Cookingham Dr	Industrial / Business Park	I-435 Hwy NB On-Ramp	I-435 Hwy NB On-Ramp	Congress Ave.
Cookingham Dr	Connector	Prairie View Rd.	Prairie View Rd.	Paris St.
Cookingham Dr	Connector	394' West of Madison Ave.	394' West of Madison Ave.	US-169 Ramp
Cookingham Dr	Connector	Prairie View Rd.	Prairie View Rd.	I-29 Hwy On-Ramp
Cookingham Dr	Suburban Commercial	Second Creek	Second Creek	Robinhood Ln.
Cookingham Dr	Connector	Robinhood Ln.	Robinhood Ln.	3408' East of Robinhood Ln.
Cookingham Dr	Suburban Commercial	Congress Ave.	Congress Ave.	Francis St.
Coal Mine Rd	Industrial / Business Park	Dr. Martin Luther King Jr. Blvd.	Dr. Martin Luther King Jr. Blvd.	Raytown Rd.
Cleveland Ave	Urban Mixed Use	WB Dr. Martin Luther King Jr. Blvd.	WB Dr. Martin Luther King Jr. Blvd.	440' South of Dr. Martin Luther King Jr. Blvd.
Cleveland Ave	Connector	Gregory Blvd.	Gregory Blvd.	67th Ter.
Cleveland Ave	Connector	Emanuel Cleaver II Blvd.	Emanuel Cleaver II Blvd.	17th St.
Cleveland Ave	Connector	Dr. Martin Luther King Jr. Blvd.	Dr. Martin Luther King Jr. Blvd.	Emanuel Cleaver II Blvd.
Cleveland Ave	Industrial / Business Park	17th St.	17th St.	16th St.
Cleveland Ave	Connector	Swope Pkwy.	Swope Pkwy.	546' North of 51st St.
Cleveland Ave	Urban Mixed Use	16th St.	16th St.	Truman Rd.
Cleveland Ave	Urban Mixed Use	67th Ter.	67th Ter.	67th St.
Chouteau Trwy	Boulevards	I-35	I-35	Antioch Rd.
Chouteau Pkwy	Parkways	Russell Rd.	Russell Rd.	I-35 Hwy On-Ramp
Chouteau Pkwy	Boulevards	I-35 Highway On-Ramp	I-35 Highway On-Ramp	I-35
Chouteau Pkwy	Parkways	M-210 Hwy On-Ramp	M-210 Hwy On-Ramp	39th St.

Chouteau Pkwy	Parkways	39th St.	Russell Rd.
Childress Ave	Connector	Old Tiffany Springs Rd.	4076' North of Old Tiffany Springs Rd.
Chestnut Trfy	Parkways	Independence Blvd.	Guinotte Via.
Chestnut Ave	Boulevards	23rd St.	21st St.
Cherry St	Neighborhood	35' South of Missouri Ave.	5th St.
Cherry St	Downtown Core	Independence Ave.	Missouri Ave.
Chatham Rd.	Suburban Commercial	Prairie View Rd.	220' North of Private Access Rd.
Charlotte St	Connector	27th St.	21st St.
Charlotte St	Downtown Core	12th St.	13th St.
Charlotte St	Downtown Core	11th St.	12th St.
Charlotte St	Downtown Core	Charlotte St.	Admiral Blvd.
Charlotte St	Downtown Core	8th St.	11th St.
Charlotte St	Downtown Core	Independence Ave.	Admiral Blvd.
Charlotte St	Downtown Core	Truman Rd.	13th St.
Charlotte St	Downtown Core	21st St.	Truman Rd.
Central Ave	Downtown Core	Wyoming St.	Hickory St.
Central Ave	Connector	State Line Rd.	Wyoming St.
Budd Park Espl St	Parkways	Brighton Ave.	Hardesty Ave.
Budd Esplanade Park	Parkways	Van Brunt Blvd.	Brighton Ave.
Brush Creek	Boulevards	Charlotte St.	Paseo Blvd.
Brush Creek	Boulevards	Rockhill Rd.	Charlotte St.
Brookside Blvd	Boulevards	Meyer Blvd.	Dr. Martin Luther King Jr. Blvd.
Brookside Blvd	Boulevards	Volker Blvd.	Emanuel Cleaver II Blvd.
Broadway St	Boulevards	31st St.	43rd St.
Broadway St	Parkways	31st St.	30th St.
Broadway St	Boulevards	Pershing Rd.	17th St.
Broadway Blvd	Boulevards	6th St.	17th St.
Brickyard Rd	Parkways	Missouri Central RR	Noland Rd.
Brickyard Rd	Parkways	Westridge Rd.	Brickyard Rd.
Brickyard Rd	Parkways	Bannister Rd.	Brickyard Rd.
Briarcliff Rd	Boulevards	Main St.	Oak Trfy.
Briarcliff Pkwy	Boulevards	Claymont Dr.	Main St.
Briarcliff Pkwy	Parkways	SB M-9 Hwy On-Ramp	452' West of Claymont Dr.

Briarcliff Pkwy	Boulevards	460' West of Claymon Dr.	Claymont Dr.
Botts Rd.	Industrial/ Business Park	Andrews Rd.	Grandview City Limit
Blue Ridge Ext	Connector	Longview Rd.	Red Bridge Rd.
Blue Ridge Ext	Suburban Commercial	US-71 Hwy Off-Ramp	Belmont Ave.
Blue Ridge Ext	Suburban Commercial	Holiday Dr.	Longview Rd.
Blue Ridge Ext	Connector	Belmont Ave.	Holiday Dr.
Blue Ridge Cutoff	Connector	Sni-A-Bar Rd.	Round Grove Creek
Blue Ridge Cutoff	Suburban Commercial	52nd St.	Sni-A-Bar Rd.
Blue Ridge Cutoff	Suburban Commercial	Stadium Entrance	I-70 Hwy On-Ramp
Blue Ridge Cutoff	Connector	EB I-70 Hwy Off-Ramp	WB I-70 Hwy On-Ramp
Blue Ridge Cutoff	Connector	Raytown City Limit	52nd St.
Blue Ridge Cutoff	Connector	247' South of East Cir.	Stadium Entrance
Blue Ridge Cutoff	Suburban Commercial	I-70 Hwy On-Ramp	38th Ter.
Blue Ridge Cutoff	Suburban Commercial	Round Grove Creek	44th St.
Blue Ridge Cutoff	Connector	38th Ter.	Independence City Limit
Blue Ridge Blvd	Connector	111th St.	107th St.
Blue Ridge Blvd	Boulevards	Bannister Rd.	87th St.
Blue Ridge Blvd	Suburban Commercial	107th St.	I-470 Highway On-Ramp
Blue Ridge Blvd	Connector	UP RR	Grandview City Limit
Blue Ridge Blvd	Suburban Commercial	State Line Rd.	Inverness Dr.
Blue Ridge Blvd	Suburban Commercial	Locust St.	UP RR
Blue Ridge Blvd	Connector	Inverness Dr.	Locust St.
Blue Ridge Blvd	Suburban Commercial	96th Ter.	Bannister Rd.
Blue Ridge Blvd	Connector	I-470 Hwy On-Ramp	96th Ter.
Blue Ridge Blvd	Suburban Commercial	195' South of 43rd St.	US 40 Hwy Access Ramp
Blue Ridge Blvd	Connector	46th Ter.	43rd Ter.
Blue Ridge Blvd	Connector	86th St.	Raytown City Limit
Blue Ridge Blvd	Suburban Commercial	87th St.	86th St.
Blue Ridge Blvd	Connector	50th Ter.	47th Ter.
Blue Ridge Blvd	Connector	31st St.	22nd Te.
Blue Ridge Blvd	Connector	Independence City Limit	Winner Rd.
Blue Ridge Blvd	Suburban Commercial	51st St.	50th Ter.
Blue Ridge Blvd	Suburban Commercial	47th Ter.	46th Ter.

Blue Ridge Blvd	Connector		Raytown City Limit	Gregory Blvd. in Raytown
Bernard Powell Dr	Connector		Cleveland Ave.	Jackson Ave.
Bern St	Connector		Mexico City Ave.	London Dr.
Berkley Pkwy	Boulevards		6th St.	Lydia Ave.
Benton Plaza	Boulevards		Benton Blvd.	Truman Rd.
Benton Blvd	Boulevards		Emanuel Cleaver II Blvd.	Linwood Blvd.
Benton Blvd	Boulevards		Dr. Martin Luther King Jr. Blvd.	Emanuel Cleaver II Blvd.
Benton Blvd	Boulevards		18th St.	Benton Plz.
Benton Blvd	Boulevards		Linwood Blvd.	23rd St.
Benton Blvd	Boulevards		Truman Rd.	Independence Ave.
Benton Blvd	Boulevards		Independence Ave.	St. John Ave.
Benton Blvd	Boulevards		21st St.	18th St.
Belmont Blvd	Boulevards		Wilson Ave.	Chouteau Trfy.
Bellevue Ave	Connector		Ward Pkwy.	43rd St.
Bellevue Ave	Connector		EB Ward Pkwy	WB Ward Pkwy
Beardsley Road	Downtown Core		River Bluff Rd.	4th St.
Beardsley Road	Connector		Forrester Rd.	361' NE of Forrester Rd.
Baughman Rd	Connector		76th St.	75th St.
Barrybrooke Dr	Connector		Barry Rd.	Montclair Ave.
Barry Rd	Connector		Barrybrooke Dr.	Green Hills Rd.
Barry Rd	Suburban Commercial		M-152 Hwy.	88' East of Cleveland Ave.
Barry Rd	Suburban Commercial		Conant Ave.	Atkins Ct.
Barry Rd	Suburban Commercial		202' West of Amity Ave.	220' West of Mace Rd.
Barry Rd	Connector		I-29 Hwy	Roanridge Rd.
Barry Rd	Suburban Commercial		Marston Rd.	N Oak Tfwy.
Barry Rd	Connector		112' East of Line Creek	Marston Ave.
Barry Rd	Suburban Commercial		102' East of Winter Ave.	128' East of I-20 Hwy On-Ramp
Barry Rd	Connector		Hampton Rd.	164' East of Forest Dr.
Barry Rd	Connector		Mace Rd.	Conant Ave.
Barry Rd	Connector		Mersington Ave.	Brighton Ave.
Barry Rd	Connector		Atkins Ct.	102' East of Winter Ave.
Barry Rd	Suburban Commercial		Roanridge Rd.	Ambassador Dr.
Barry Rd	Connector		Brighton Ave.	Sam Ray Rd.

Barry Rd	Connector	Kenwood Ave.	M-152 Hwy.
Barry Rd	Suburban Commercial	Hodge Park Rd.	580' East of Crystal Ave.
Barry Rd	Connector	Sam Ray Rd.	Hodge Park Rd.
Barry Rd	Suburban Commercial	N Oak Tfwy.	Kenwood Ave
Barry Rd	Parkways	Barry Rd.	Shoal Creek Pkwy.
Barry Rd	Connector	88' East of Cleveland Ave.	Mersington Ave.
Barry Rd	Suburban Commercial	Green Hills Rd.	553' East of Green Hills Rd.
Bannister Rd	Connector	State Line Rd.	496' East of Summit St.
Bannister Rd	Connector	UP RR	350' US-71 Hwy Off-Ramp
Bannister Rd	Connector	484' West of Wornall Rd.	168' East of Duke Creek
Bannister Rd	Suburban Commercial	500' East of Summit St.	482' West of Wornall Rd.
Bannister Rd	Suburban Commercial	350' West of Holmes St.	333' West of Lydia Ave.
Bannister Rd	Parkways	Blue Ridge Blvd.	W. Longview Pkwy.
Bannister Rd	Thoroughfare	Hill Crest Rd.	Blue Ridge Blvd.
Bannister Rd	Thoroughfare	I-435 Hwy Off-Ramp	Hillcrest Rd.
Bannister Rd	Thoroughfare	West Longview Pkwy	Valley Garden Dr.
Bannister Rd	Thoroughfare	Valley Garden Dr.	M-350 Hwy On-Ramp
Bannister Rd	Suburban Commercial	618' West of Marion Park Dr.	I-435 Highway On-Ramp
Bannister Rd	Industrial / Business Park	333' West of Lydia Ave.	UP RR
Baltimore Ave	Downtown Core	9th St.	WB Truman Rd.
Baltimore Ave	Downtown Core	EB Truman Rd.	19th St.
Baltimore Ave	Downtown Core	WB Truman Rd.	EB. Truman Rd.
Avenida Cesar E. Chavez	Industrial / Business Park	American Royal Dr.	Allen St.
Avenida Cesar E. Chavez	Connector	Allen St.	Bellevue Ave.
Avenida Cesar E Chavez	Connector	KCMO City Limit	American Royal Dr.
Askew Ave	Parkways	West Meyer Blvd. Roundabout	West Meyer Blvd. Roundabout
Armour Blvd	Boulevards	Broadway Blvd.	Paseo Blvd.
Andrews Rd	Industrial / Business Park	Andrews Rd.	155th St.
Amity Ave.	Industrial / Business Park	Tiffany Springs Pkwy.	104th St.
American Royal Dr	Connector	Avenida Cesar E. Chavez	Genesee St.
Ambassador Dr	Industrial / Business Park	Tiffany Springs Pkwy.	122nd St.
Ambassador Dr	Suburban Commercial	Barry Rd.	Boardwalk Ave.
Ambassador Dr	Connector	Old Tiffany Springs Rd.	Tiffany Springs Pkwy.

Ambassador Dr	Industrial / Business Park	122nd St.	128th St.
Agnes Ave	Connector	Cookingham Dr.	KCMO City Limit
Admiral	Boulevards	Paseo Blvd.	Highland Ave.
9th St	Downtown Core	Broadway Blvd.	I-70
9th St	Urban Mixed Use	I-70	Paseo Blvd.
9th St	Urban Mixed Use	Wabash Ave.	Prospect Ave.
9th St	Connector	Gladstone Ave.	78' East of Jackson Ave.
9th St	Connector	Prospect Ave.	Agnes Ave.
9th St	Connector	Woodland Ave.	Garfield Ave.
9th St	Urban Mixed Use	Highland Ave.	Woodland Ave.
9th St	Boulevards	Paseo Blvd.	Highland Ave.
9th St	Urban Mixed Use	Denver Ave.	Hardesty Ave.
9th St	Connector	Brooklyn Ave.	Wabash Ave.
9th St	Connector	Kensington Ave.	Van Brunt Blvd.
9th St	Urban Mixed Use	75' East of Jackson Ave.	20' East of Kensington Ave.
9th St	Industrial	Hardesty Ave.	Winner Rd.
9th St	Urban Mixed Use	Van Brunt Blvd.	Brighton Ave.
9th St	Connector	Brighton Ave.	Denver Ave.
9th St	Urban Mixed Use	Agnes Ave.	Gladstone Ave.
9th St	Urban Mixed Use	Garfield Ave.	Brooklyn Ave.
96th St.	Parkways	US 169 Hwy.	Oak Trfy.
96th St.	Connector	Lawn Ave.	Brighton Ave.
96th St	Parkways	Topping Ave.	312' East of I-435 Hwy Off-Ramp
96th St	Connector	Little Shoal Creek	Cookingham Dr.
96th St	Suburban Commercial	Tullis Dr.	Little Shoal Creek
96th St	Boulevards	97' East of Oak Trfy.	West Fork Shoal Creek
96th St	Parkways	Brighton Ave.	Topping Ave.
96th St	Connector	Brooklyn Ave.	Indiana Ave.
96th St	Connector	Maplewoods Pkwy.	Brooklyn Ave.
96th St	Connector	Shoal Creek Pkwy	Tullis Dr.
87th St	Suburban Commercial	Blue River Rd.	180' East of Newton Ave.
87th St	Parkways	Oldham Rd.	Blue Ridge Blvd.
87th St	Connector	85th St.	Blue River Rd.

85th St	Suburban Commercial	Troost Ave.	Tracy Ave.
85th St	Industrial / Business Park	Prospect Ave.	Hickman Mills Dr.
85th St	Connector	187' West of State Line Rd.	Holmes Rd.
85th St	Neighborhood	State Line Rd.	187' East of State Line Rd.
85th St	Connector	Troost Ave. Access Rd.	Troost Ave.
85th St	Connector	Tracy Ave.	Olive St.
85th St	Suburban Commercial	Holmes Rd.	Troost Ave. Frontage
85th St	Suburban Commercial	Olive St.	Prospect Ave.
7th St	Boulevards	Locust St.	Paseo Blvd.
7th St	Boulevards	Grand Blvd.	Page St.
7th St	Boulevards	Page St.	Oak St.
7th St	Boulevards	Oak St.	Locust St.
79th St	Connector	Oldham Rd.	264' West of Spring Valley Rd.
79th St	Connector	State Line Rd.	Wornall Rd.
79th St	Boulevards	Rhinehart Rd.	Little Blue Rd.
79th St	Boulevards	Noland Rd.	Rhinehart Rd.
75th St	Connector	Forest Ave.	Wabash Ave.
75th St	Industrial / Business Park	Montgall Ave.	Bruce R. Watkins Road NB Access Road
75th St	Urban Mixed Use	Wabash Ave.	Montgall Ave.
75th St	Connector	Wyoming St.	Pennsylvania Ave.
75th St	Urban Mixed Use	Pennsylvania Ave.	Baltimore Ave.
75th St	Connector	Baltimore Ave.	Cherry Vue Rd.
75th St	Urban Mixed Use	Harrison St.	Forest Ave.
75th St	Urban Mixed Use	Cherry Vue Rd.	Charlotte St.
75th St	Connector	Charlotte St.	Harrison St.
75th St	Boulevards	Murkins Rd.	Noland Rd.
75th St	Boulevards	550' East of Marion Rd.	Murkins Rd.
75th St	Urban Mixed Use	State Line Rd.	Wyoming St.
72nd St	Connector	Overland Dr.	Waukomis Dr.
6th St	Downtown Core	Beardsley Rd.	6th St./I-35
63rd Trfy	Connector	Zoo Dr.	I-435 Hwy On-Ramp
63rd St	Boulevards	Paseo Blvd. Southbound	Paseo Blvd. Northbound
63rd St	Connector	State Line Rd.	Wornall Rd.

63rd St	Urban Mixed Use	Wornall Rd.	Main St.
63rd St	Urban Mixed Use	Morningside Dr.	Paseo Blvd.
63rd St	Connector	Bushman Dr.	Citadel Dr.
63rd St	Urban Mixed Use	Citadel Dr.	Bruce R. Watkins Drive Access Ramp
63rd St	Connector	Bruce R. Watkins Dr.	Zoo Dr.
63rd St	Connector	I-435 Hwy On-Ramp	Blue Parkway Dr.
63rd St	Suburban Commercial	600' East of Blue Pkwy.	Blue Ridge Ct of
63rd St	Urban Mixed Use	Paseo Blvd. Northbound	Bushman Dr.
63rd St	Connector	Main St.	Morningside Dr.
55th St	Connector	Oak St.	Wabash Ave.
55th St	Connector	Ward Pkwy.	Brookside Blvd.
55th St	Urban Mixed Use	Wabash Ave.	Bruce R. Watkins Dr.
55th St	Connector	Bruce R. Watkins Dr.	Cleveland Ave.
55th St	Urban Mixed Use	Brookside Blvd.	Oak St.
51st St	Connector	Palmer Dr	Skiles Ave
47th St	Urban Mixed Use	Madison Ave.	Mill Creek Pkwy.
47th St	Boulevards	Mill Creek Pkwy.	Main St.
47th St	Suburban Commercial	Westridge Rd.	Woodside Ave.
47th St	Connector	508' East of Raytown Rd.	Westridge Rd.
47th St	Suburban Commercial	Raytown Rd.	500' East of Raytown Rd.
47th St	Connector	Woodside Ave.	Fuller Ave.
43rd St	Connector	Pennsylvania Ave.	Baltimore Ave.
43rd St	Urban Mixed Use	Baltimore Ave.	Main St.
43rd St	Urban Mixed Use	State Line Rd.	Madison Ave.
43rd St	Connector	Madison Ave.	Jefferson St.
43rd St	Urban Mixed Use	Jefferson St.	Pennsylvania Ave.
40th St.	Industrial / Business Park	Birmingham	Norfleet Rd.
3rd St	Downtown Core	Beardsley Rd.	Woodswether Rd.
39th St	Urban Mixed Use	Harrison Blvd.	Forest Ave.
39th St	Urban Mixed Use	State Line Rd.	Locust St.
39th St	Connector	Locust St.	Harrison St.
39th St	Connector	Agnes Ave.	Kensington Ave.
39th St	Urban Mixed Use	South Benton Ave.	Agnes Ave.

39th St	Connector	Forest Ave.	Woodland Ave.
39th St	Connector	Garfield Ave.	Wabash Ave.
39th St	Connector	Cypress Ave.	Chelsea Dr.
39th St	Connector	Michigan Ave.	Garfield Ave.
39th St	Urban Mixed Use	Woodland Ave.	Michigan Ave.
39th St	Urban Mixed Use	Wabash Ave.	Montgall Ave.
39th St	Connector	Montgall Ave.	Sount Benton Ave.
39th St	Urban Mixed Use	Kensington Ave.	Cypress Ave.
35th St	Connector	Paseo	Highland Ave.
35th St	Connector	Woodland Ave.	Wabash Ave.
35th St	Connector	Montgall Ave.	Indiana Ave.
35th St	Urban Mixed Use	Wabash Ave.	Montgall Ave.
35th St	Connector	Bales Ave.	Cleveland Ave.
35th St	Urban Mixed Use	Indiana Ave.	Bales Ave.
35th St	Urban Mixed Use	Highland Ave.	Woodland Ave.
33rd St	Connector	Southwest Trfy.	Broadway Blvd.
31st St	Urban Mixed Use	Broadway Blvd.	Walnut St.
31st St	Boulevards	Southwest Trfy.	Broadway Blvd.
31st St	Connector	Walnut St.	Cherry St.
31st St	Urban Mixed Use	Holmes St.	Troost Ave.
31st St	Industrial / Business Park	Southwest Blvd.	Roanoke Rd.
31st St	Urban Mixed Use	Cleveland Ave.	Spruce Ave.
31st St	Urban Mixed Use	Bruce R. Watkins Access Rd.	Agnes Ave.
31st St	Urban Mixed Use	Paseo Blvd.	Michigan Ave.
31st St	Connector	Agnes Ave.	College Ave.
31st St	Industrial / Business Park	Cherry St.	Holmes St.
31st St	Connector	Spruce Ave.	Poplar Ave.
31st St	Connector	Bales Ave.	Cleveland Ave.
31st St	Connector	Michigan Ave.	Bruce R. Watkins Access Road Pkwy
31st St	Connector	Roanoke Rd.	Terrace St.
31st St	Connector	Troost Ave.	Paseo
31st St	Connector	Mercier St.	Summit St.
31st St	Urban Mixed Use	Poplar Ave.	Stadium Dr.

31st St	Industrial / Business Park	Terrace St.	Mercier St.
31st St	Urban Mixed Use	College Ave.	Bales Ave.
27th St	Connector	Gilham Rd.	Brooklyn Ave.
27th St	Downtown Core	Main St.	Gilham Rd.
27th St	Urban Mixed Use	Askew Ave.	I-70
27th St	Urban Mixed Use	Brooklyn Ave.	Agnes Ave.
27th St	Connector	Agnes Ave.	Walrond Ave.
27th St	Connector	50' East of Spruce Ave.	Van Brunt Blvd.
27th St	Connector	135' East of I-70 Hwy SB Off-Ramp	Norton Ave.
27th St	Connector	Bales Ave.	Askew Ave.
27th St	Urban Mixed Use	Walrond Ave.	College Ave.
27th St	Urban Mixed Use	Norton Ave.	Spruce Ave.
27th St	Urban Mixed Use	Indiana Ave.	Bales Ave.
27th St	Connector	College Ave.	Indiana Ave.
23rd Trfy	Thoroughfare	Television Pl.	Independence City Limit
23rd St	Thoroughfare	I-435 Hwy Off-Ramp	Television Pl.
23rd St	Connector	Askew Ave	Topping Ave
23rd St	Boulevards	Chestnut Ave.	Kansas Ave.
23rd St	Urban Mixed Use	Kansas Ave.	50' East of Agnes Ave.
23rd St	No typology	I-70 Hwy Off-Ramp	Askew Ave.
23rd St	Urban Mixed Use	Prospect Ave.	Benton Blvd.
23rd St	Connector	I-70 Hwy SB On-Ramp	I-70 Hwy NB On-Ramp
23rd St	Industrial / Business Park	312' East of Big Blue River	I-435 Hwy SB On-Ramp
23rd St	Industrial / Business Park	Indiana Ave.	I-70 Hwy SB On-Ramp
23rd St	Connector	Bellevue Ave.	Southwest Blvd.
23rd St	Connector	Agnes Ave	Indiana Ave
23rd St	Connector	Topping Ave.	550' West of BNSF RR
22nd St	Connector	Charlotte St	Olive St
22nd St	Boulevards	Grand Blvd.	Charlotte St.
22nd St	Connector	Olive St	Prospect Ave
20th St	Downtown Core	I-35 SB Off Ramp	Southwest Blvd.
19th St	Downtown Core	Baltimore Ave.	Main St.
18th St.	Industrial / Business Park	Euclid Ave.	Prospect Ave.

18th St	Downtown Core	Walnut St.	Bruce R. Watkins Dr.
18th St	Connector	Bruce R. Watkins	Paseo
18th St	Urban Mixed Use	Paseo Blvd.	Woodland Ave.
18th St	Connector	Prospect Ave	KCT RR
18th St	Connector	I-70 Hwy	Cleveland Ave
18th St	Downtown Core	Broadway Blvd.	Baltimore Ave.
18th St	Downtown Core	Baltimore Ave.	Wainut St.
18th St	Connector	Woodland Ave	Euclid Ave
18th St	Industrial / Business Park	KCT RR	I-70 Hwy.
17th St	Connector	Jackson Ave.	Hardesty Ave.
155th St	Industrial / Business Park	US-71 Hwy SB On-Ramp	US-71 Hwy NB On-Ramp
155th St	Industrial / Business Park	Kensington Ave.	Scott Ave.
155th St	Connector	Kelley Rd.	Lee's Summit City Limit
155th St	Industrial / Business Park	Scott Ave.	US-71 Hwy SB On-Ramp
14th St	Downtown Core	Wyandotte St.	Grand Blvd.
14th St	Downtown Core	Pennsylvania Ave.	Wyandotte St.
14th St	Downtown Core	Oak St.	Charlotte St.
13th St	Downtown Core	Pennsylvania Ave.	Main St.
13th St	Downtown Core	Locust St.	Charlotte St.
13th St	Downtown Core	Walnut St.	Locust St.
13th St	Downtown Core	Main St.	Walnut St.
139th St	Connector	Holmes Rd.	Prospect Ave.
139th St	Connector	Grandview City Limit	Peterson Rd.
139th St	Connector	Peterson Rd.	Lee's Summit City Limit
136th St.	Industrial / Business Park	Bethel Ave.	Winan Ave.
135th St	Urban Mixed Use	Wyandotte St.	Holmes Rd.
135th St	Suburban Commercial	M-150 Hwy.	Wyandotte St.
132nd St	Industrial / Business Park	Mexico City Ave.	Winan Ave.
12th St	Connector	Genessee St.	Liberty St.
12th St	Downtown Core	I-35 SB On-Ramp	Broadway Blvd.
12th St	Downtown Core	Broadway Blvd.	Wyandotte St.
12th St	Downtown Core	Baltimore Ave.	I-70
12th St	Connector	I-70	Euclid Ave.

12th St	Connector	Park Ave.	Propect Ave.
12th St	Urban Mixed Use	Prospect Ave.	Chestnut Ave.
12th St	Urban Mixed Use	Bellefontaine Ave.	Indiana Ave.
12th St	Urban Mixed Use	Askew Ave.	Jackson Ave.
12th St	Connector	Van Brunt Blvd.	Winchester Ave.
12th St	Connector	Bluff Rd.	I-35 Hwy Off-Ramp
12th St	Industrial / Business Park	Jackson Ave.	Van Brunt Blvd.
12th St	Connector	Indiana Ave.	Askew Ave.
12th St	Connector	Chestnut Ave.	Bellefontaine Ave.
12th St	Downtown Core	Wyandotte St.	Baltimore St.
12th St	Boulevards	Van Brunt Blvd.	Van Brunt Blvd.
12th St	Urban Mixed Use	Euclid Ave.	Park Ave
12th St	Downtown Core	Liberty St.	Beardsley Rd.
128th St	Connector	US-169 Hwy	Virginia Ave.
128th St	Connector	Winan Ave.	Interurban Rd.
128th St	Connector	Robinhood Ln.	128th St.
128th St	Connector	128th St.	US-169 Hwy
126th St	Connector	Virginia Ave	Woodland Ave
11th St	Downtown Core	Broadway Blvd.	Main St.
11th St	Downtown Core	Walnut St.	Bruce R. Watkins Access Road Ramp
11th St	Downtown Core	Main St.	Walnut St.
11th St	Connector	I-70	Paseo Blvd.
10th St	Downtown Core	Wyandotte St.	Walnut St.
10th St	Downtown Core	Broadway Blvd.	Wyandotte St.
10th St	Downtown Core	Grand Blvd.	Locust St.
10th St	Downtown Core	Walnut St.	Grand Blvd.
10th St	Downtown Core	Locust St.	I-70
10th St	Urban Mixed Use	I-70	Paseo Blvd.
109th St	Parkways	Raytown Rd.	View High Dr.
107th St	Connector	Blue Ridge Blvd.	James A Reed Rd.
104th St.	Industrial / Business Park	Amity Ave.	Everton Ave.
104th St	Connector	Cookingham Dr.	City Limit
NE 108th St	Connector	Shoal Creek Pkwy.	Hardesty Ave.

Mexico City Ave

Industrial / Business Park

132nd St.

136th St.,

KCMO Safe Streets for All - Streets Design Guide

November 2025



Table of Contents

Introduction	3
Safe Streets Principles	5
Street Typologies	20
Downtown Core	23
Urban Mixed-Use	28
Suburban Commercial	33
Thoroughfare	38
Connector	43
Neighborhood	47
Industrial / Business Park	53
Boulevards	58
Parkways	62
Design Guidance	68
Implementation	90

Introduction

Kansas City's Streets Design Guide (SDG) was developed through a Safe Streets for All (SS4A) grant awarded to Kansas City by FHWA to conduct supplemental planning efforts to help implement the City's Vision Zero Action Plan. The purpose of the SDG is to help focus Kansas City's (the City's) street design, construction, maintenance, and rehabilitation projects on safety, multimodal access, context sensitivity, and speed management. This Streets Design Guide is an effort to update city design standards in accordance with the Vision Zero and Complete Streets policies and to bring them into a single document for use by City staff and design consultants.

In 2020, the City Council passed the Vision Zero resolution to eliminate traffic fatalities and serious injuries on Kansas City streets by 2030, while increasing safe, healthy, equitable mobility for everyone. This document will support and expand the work already underway across the City's transportation network to reduce fatalities and injuries by standardizing practices that reduce speeds; reduce conflict points; provide safer facilities for pedestrians, cyclists and other vulnerable road users; and provide clearer guidance to drivers and other roadway users.

This document updates and replaces the City's previous 5200 Street Design Criteria. It also introduces new roadway typologies, replacing those previously shown in the Major Street Plan. This document also references design standards for Boulevards and Parkways, trails, personal mobility lanes (also known as bike facilities), and transit corridors from other City documents.

Organization of the Streets Design Guide

The Streets Design Guide is organized into four sections:

1. **Safe Streets Principles** provides the foundational framework for reducing the likelihood and severity of crashes on the street network and the justification for the City's design standards.
2. **Street Typologies** illustrates the street categories for which design guidance and standards are to be applied.
3. **Design Guidance** presents standards and guidance for the design of common corridor and intersection elements in accordance with safe streets principles.
4. **Implementation** guides the reader through the process of prioritizing and executing different project types in accordance with safe streets principles and the City's design standards and policies.

How to Use the Streets Design Guide

The Streets Design Guide serves several audiences and purposes, all centered around promoting a culture of safety within every project on the transportation network.

For design consultants: The Design Guidance section of the SDG serves as a one-stop-shop for the City's street design standards, policies, and guidance. The Street Typologies section provides guidance for additional design choices based on roadway typology.

For City project managers: The Design Guidance section provides the standards that designers and consultants are required to follow and should be verified by project managers. The Street Typologies section provides guidance for design choices for which designers may seek guidance. The Safe Streets Principle section documents the City's priorities and rationale for the design guidance presented in later chapters.

For City Public Works staff: The implementation guidance in the Implementation section points to safety improvements that can be incorporated during executes public works projects that require street maintenance activities.

For City Parks and Recreation staff: Design standards for Boulevards and Parkways are set by the Parks and Recreation department and have historically been centered around preserving a specific look and feel for those corridors. The Street Typologies section of the SDG includes Boulevards and Parkways as street typologies, acknowledging their historical context while adding best practices for safer operations and multi-modal access.

For maintenance crews: The design standards presented in the Design Guidance section illustrate changes to the way common corridor and intersection elements are designed. Maintenance activities often provide an opportunity to update some street elements in alignment with new standards. Before rebuilding a facility to its previous design, maintenance crews should verify their projects meet updated city policies and practices.

For construction contractors: As projects are let, design elements may be different than what contractors are used to building. The Design Guidance section can be referenced to verify unexpected design elements are correct and the Street Typologies section can be referenced to learn more about justification for the changes.

For elected officials: The Street Typologies section, and the associated City Street Typologies map, can be shared with constituents to show them the intended functionality of their streets and the design standards the City will be using to update their streets over time. The entire document can also be used to highlight the City's commitment to transportation safety and the standards and policy changes being implemented to reduce fatal and serious injury crashes.

For safety advocates: The SDG carries forward the recommendations from the City's Vision Zero Action Plan, which was developed by a multi-disciplinary group and informed by thorough community engagement. It shows a shift in focus from efficiency for automobile trips to safety and accessibility for all users. Safety advocates can use the document to take pride in the work completed to date and to push for continued safety improvement on our streets.

Safe Streets Principles

The principles discussed here are the foundation of design standards and guidance presented later in this document. They draw on industry knowledge—including from the National Association of City Transportation Officials (NACTO), the American Association of State Highway and Transportation Officials (AASHTO), and the National Cooperative Highway Research Program (NCHRP)—as well as key resources developed by the City, including the 2022 Vision Zero Action Plan and the Complete Streets Ordinance (Ordinance No. 170949).

This Guide continues well-established practices and procedures for street design but increases focus on access and safety for all users. Acknowledging that too many citizens are being killed and injured on our streets, this Street Design Guide employs strategies for speed management, increases the priority of pedestrian and personal mobility facilities, and makes it easier for designers to include safety features in their projects. The guidance presented is based on decades of traffic safety research and experience.

Streets are important public spaces that can create a sense of place, provide mobility, and support economic vitality. This Guide acknowledges that street design involves delicate management of competing needs and limited resources. No set of design standards can be sufficiently comprehensive as to address every circumstance. In cases that are not covered explicitly or where engineering judgement determines a standard is not appropriate or applicable, the principles discussed in this section can be used as a foundation for decision-making during the design process.

Many effective safety techniques can be applied quickly and easily to any project, especially when using a “quick build” or incremental design approach. Some of the most common scenarios include when:

- citizens bring specific safety concerns to the City’s attention;
- safety analysis from the City or its consultant identifies an acute safety concern;
- a new street is constructed;
- an existing street is reconstructed;
- an ADA project is planned;
- a maintenance or pavement project is scheduled;
- a utility project is planned within the street right-of-way; or
- a planning or engineering study is being conducted.

Application concepts are discussed further in the Implementation chapters of this document. Incorporating safety into every project shows a commitment to a culture of safety and maximizes the benefit of safety investments.

Street Users

All street users deserve streets that are safe and convenient, regardless of which mode they choose. Streets have historically been designed to prioritize the movement of traffic, focusing first and foremost on motor vehicles. Today, designers can better quantify crash risk and are more likely to consider safety in their design choices. This benefits people using the transportation system, whether they are walking, rolling, or in a vehicle.

A safety focus means fatal and serious injury crashes are a higher priority than fender-benders. And, because pedestrians and cyclists are more vulnerable to serious injury when involved in a crash, designers must prioritize the reduction of crash risk for those groups. In Kansas City, pedestrians and cyclists make up only 2% of crashes, but these vulnerable users are involved in 22% of crashes resulting in serious injury or death.

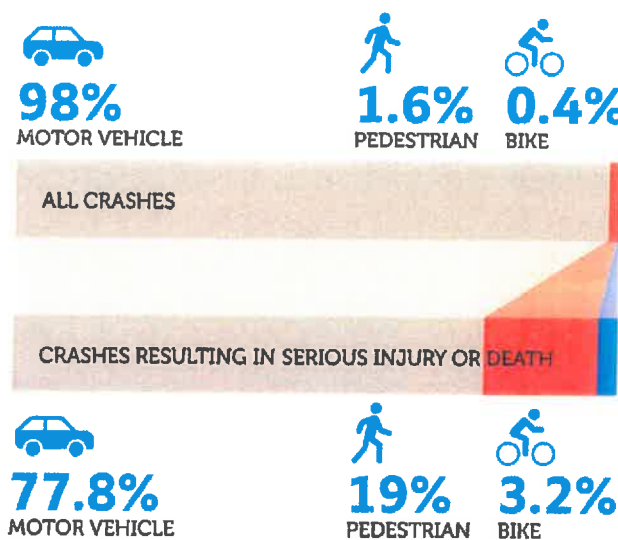

While personal vehicles are the most common mode on city streets, they generally create more risk for vulnerable users than they experience. Operational considerations for motor vehicles are important but should be considered after the safety needs of all other users have been considered and addressed to the extent possible.

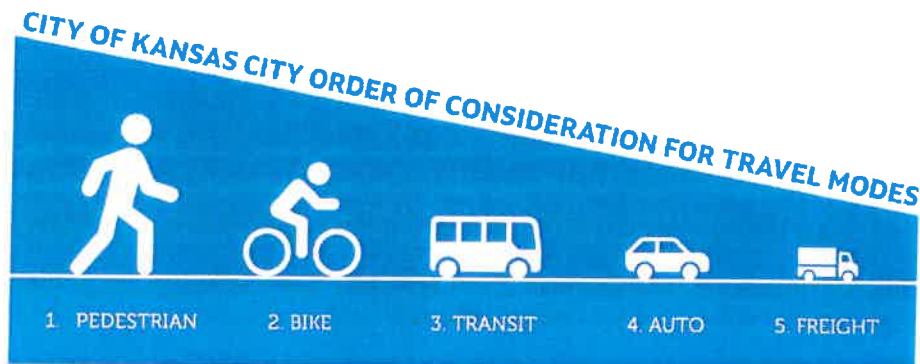

Pedestrians

Pedestrians are the most vulnerable street users and can include people with unique needs: children, the elderly, or users with limited mobility or vision. Everyone is a pedestrian at times: when they traverse a parking lot, go from their home to a transit stop, or cross the street in a shopping district. All streets should provide dedicated space for pedestrians. Locations with frequent pedestrian traffic, or near residential areas, schools, churches, or shopping/dining districts should emphasize lower vehicle speeds, connected pedestrian sidewalks or paths, high-visibility crossings, lighting, and other amenities to increase comfort, such as benches and shade.

Streets that are primarily designed to accommodate faster-moving vehicles should prioritize separation between vehicle traffic and pedestrians. Where right-of-way is constrained, consideration should be given to reducing pavement width and accommodations for motor vehicles before reducing sidewalk width or buffer space. Additionally, enhanced crossing treatments should be prioritized, at both intersections and mid-block locations, with median refuge areas, actuated pedestrian beacons or signal phases, long sight distances, and advanced signing. Beyond meeting regulatory and design guidance, care should be taken to accommodate pedestrians with mobility or visual limitations where they are expected, including by enhancing the visibility of pedestrians and increasing crossing time.

Shade trees, benches, pedestrian-level lighting, wayfinding, and other features create a sense of place and make users feel more safe and secure. However, maintenance of pedestrian infrastructure and amenities is essential. Sidewalk cracks and trip hazards can make it difficult or impossible to move in a wheelchair or push a stroller, and some features may block the view of pedestrians for motor vehicle drivers. Plantings should be designed so as to prevent roots pushing up on sidewalks, minimize sight obstructions between motor vehicles and pedestrians, and help manage storm water. Where right-of-way is limited, street designers should pay special attention to roadside elements (such as utilities or light poles) that may infringe on pedestrian space.

At intersections, street designers should be cautious of vehicle turn lanes or other features that increase pedestrian crossing distance or allow higher turning speeds. Where street intersections are widely spaced or where trip generators exist at midblock locations, consideration should be given to providing midblock crossing locations with high-visibility pavement marking and signs, and rectangular rapid flashing beacons or pedestrian signals where appropriate.



Bicycles and Other Micromobility Devices

Bicyclists—as well as those on scooters and other micromobility devices—are the next most vulnerable street users. Like pedestrians, bicyclists need more separation from motor vehicle traffic as vehicle speeds increase. On low-speed, low-volume facilities, bicyclists may be able to ride in the lane with motor vehicle traffic; on high-speed, high-volume streets, bicyclists should be separated entirely from the roadway.

Bicyclists, scooter users and other micromobility users can be especially sensitive to topography. Where traffic moves uphill, bicyclists can be expected to move slower relative to vehicles and should receive greater protection. At intersections, bicyclists should be conspicuous to vehicles and be given traffic signal or physical priority (in bike boxes, for example) to establish their presence.



Transit

Increasing the share of residents who use transit improves safety, supports urban density, and reduces emissions. For transit to be effective, it must be reliable and frequent. Operation of transit vehicles in mixed traffic increases the risk of delays, especially at peak times. Designated transit lanes and transit priority at intersections can reduce this risk and make transit more attractive.

The transit network is dependent on the pedestrian, personal mobility (bike), and micromobility/microtransit networks because total trip time includes time getting to and from transit stops. Street designers should be thoughtful about modal connections to transit stops and amenities provided to waiting riders.



Freight

Freight movement is necessary to support economic activity. Freight vehicles are likely to be constrained by the geometry of the roadway and may require additional space for turning movements. These space demands are often similar to those of emergency services and maintenance vehicles and school buses. In areas with pedestrians and/or cyclists, designers should consider elements that balance the needs of both large vehicles and vulnerable users, such as mountable curbs, truck aprons, and recessed stop bars that accommodate wider turns into the opposing lane of traffic.

In denser areas, freight vehicles may also require loading/unloading space along the street. This may be achieved in shared space with other features, such as street parking; however, freight vehicles should never occupy designated pedestrian or bicyclist space. Common freight vehicles will vary by roadway typology and context. Time-of-day restrictions on truck parking and loading/unloading can limit freight conflict with other modes.

Passenger Vehicles

On much of the City's transportation network, passenger vehicles are the most common user type. However, geometric and traffic control elements designed to reduce vehicle delay can have unintended safety consequences. Street designers should choose street elements that reinforce the intended speed (see "Speed" below). Because of motor vehicle size and speed, the roadway environment should be designed to help drivers see other users, especially through the provision of clear sight lines to pedestrians, bicyclists, and other vehicles at intersections and crossings.

As the motor vehicle fleet continues to incorporate new technologies that increase automation and connectivity, the roadway design should support such technologies. This suggests a focus on design consistency and highly visible pavement markings and traffic control devices.

Safety Concepts

While “safer roads” is only one element of five in a safe system approach, it is the primary tool for designers to mitigate crash risk. Street design should vary according to adjacent land uses and expected users. This section addresses the various elements that establish a street’s character. The use of design elements within particular contexts is explained in “Typologies”.

Speed

Implications for Safety

Speed management is a critical component of street safety. Traffic speeds are directly related to crash likelihood and severity because they impact:

- The energy transferred in a crash, with energy being proportional to the square of speed
- The distance traveled while a driver perceives and reacts to a hazard or risk
- The size of the driver’s visual field (the area where a driver can observe and interpret visual information)

Moderate increases in speed can substantially increase the risk of a fatal crash. A street user’s likelihood of surviving being struck by a motor vehicle is 90 percent at 23 mph, 50 percent at 42 mph, and only 10 percent at 58 mph. Children and the elderly are much more likely to be killed at all speeds.

Furthermore, high vehicle speeds can make crashes more likely, as faster cars move greater distances before drivers can perceive hazards, brake, and come to a stop. The figure below shows average stopping distances, including driver reaction distance and braking distance, at increasing speeds for passenger vehicles on dry and wet pavement. It shows, for example, that a passenger vehicle traveling at 40 mph requires more than double the stopping distance of the same vehicle traveling at 25 mph. For heavy vehicles, stopping distance is even greater than what is shown in this chart.

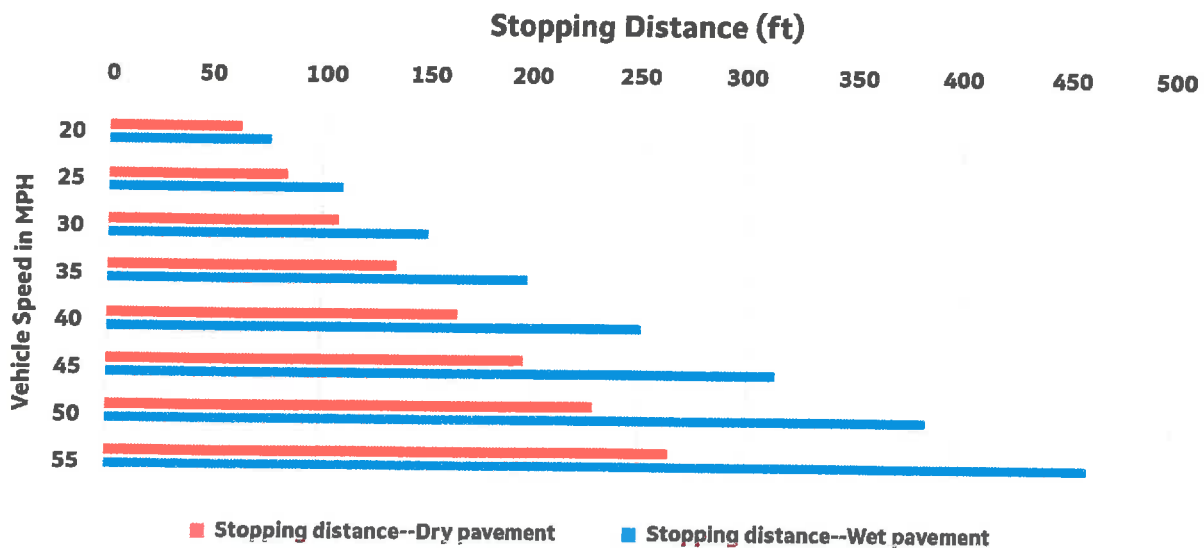

Higher driving speeds also narrow a driver's field of vision, making it more difficult to see an approaching animal, pedestrian, cyclist, or vehicle approaching from the side, as illustrated below.

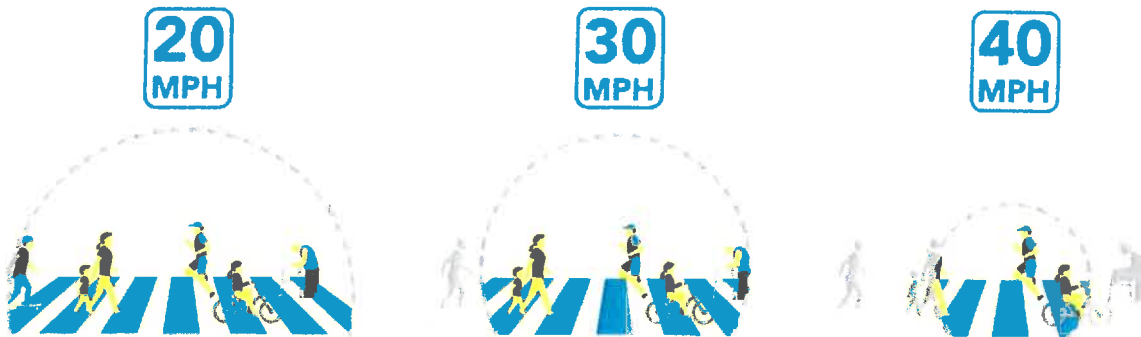

Source: Vision Zero Network (<https://visionzeronet.org/resources/safety-over-speed/>)

Designing to Manage Speeds

Ideally, streets are “self-enforcing”: their design and surrounding land use convey the appropriate travel speed even in the absence of speed limit signs. Because drivers have a lot of visual information to process (especially in dense, urban areas), and speeds are not posted on every block, they rely on clues—often subconsciously—to help them choose their travel speed. Such clues might include lane width; how congested the street is; proximity of objects such as trees, signs, and utility poles to the street; the presence of pedestrians and cyclists; nearby playgrounds, schools, and other indications that children use the street; the frequency of residential and commercial driveways; the allocation of pavement width to parking, transit lanes, personal mobility lanes, or medians; and, perhaps most importantly, the speed of other drivers on the road.

Self-enforcing roads are most effective when roadway characteristics consistently align with the posted speed limit. A comprehensive speed limit review across the City showed that posted speed limits signs did not strongly correlate with mean and 85th-percentile speeds. Instead, features such as on-street parking were much more correlated with driving speeds that were aligned with posted speed limits. Additionally, since drivers rely on their cumulative driving experience to choose travel speed, reducing speed limits as a safety treatment on only some streets may lead to driver confusion about what driving speed is safe and appropriate in a given context.

Rather than using a design speed that exceeds anticipated driving speed or posted speed limit, street designers should set a target speed (see “Elements of Design”) that aligns with the context of the roadway and its expected users. This target speed should be reflected in geometric features, access control, signal timing, modal accommodations and the posted speed limit, which, in turn, are aligned with adjacent land use, development, and density. The Target Speed on a road may not match the existing posted speed limit. The design speed and posted speed limits should be re-evaluated based on the Streets Design Guide and the assigned Street Typology’s Target Speed each time a roadway project occurs.

However, even the best-designed streets can provide inconsistent clues to drivers. For example, some streets may be congested during certain times of day but clear at others. Pedestrians may be present immediately before and after school but infrequent otherwise. The proximity and

density of the streetside landscape may feel different during the spring and summer when foliage is in full bloom than when leaves are absent and sight distance is increased.

Traffic calming measures can bring consistency to travel speeds by creating conditions that require driver awareness and careful control of the vehicle. The following strategies, which can often be accomplished with lower-cost interim treatments, can reduce speeds on an existing street:

- Road diet (from 4 lanes to 3)
- Reduced lane width and intersection corner radii
- Traffic calming devices (speed humps, raised medians)
- Coordination of traffic signals to support traffic progression at a slower speed and prioritize pedestrians and bicyclists (such as leading pedestrian intervals)
- Roundabouts at intersections
- On-street parking and curb extensions
- Street enhancement features (textured pavement, street trees)
- Elimination of slip lanes, channelized right-turn lanes, and other features that encourage faster speeds at conflict points

Traffic calming can be implemented either as a correction to observed high speeds or as an intentional feature on new and reconstructed streets. When implemented as a remedy for an observed speeding problem, they are frequently initiated in response to requests from the public. The process for selecting locations for traffic calming measures and choosing the appropriate measure is detailed in the *Traffic Engineering and Operations Manual*.

Geometry

In many cases, street designs intended to reduce the likelihood of conflicts and crashes (such as wider lanes or gentler curves) actually encourage faster driving speeds, because they make drivers feel comfortable going faster. These oversized streets often result in more severe crashes. Accordingly, designers should seek to use geometric design to balance the risk of collisions with the potential severity of crashes.

Design and Control Vehicles

A related concept is the distinction between a “design vehicle” (the largest vehicle commonly expected on the street) and a “control vehicle” (the largest vehicle ever expected on the street). A typical design vehicle might be a smaller box truck, while a typical control vehicle might be a large combination freight truck, school bus, or fire engine.

Unlike the design vehicle, the control vehicle can use additional space for turning movements, including the adjacent and opposing travel lanes or mountable curbs, as shown in the figure below. Street designers should select the smallest appropriate design vehicle. This distinction allows designers to reduce the geometry of the roadway, especially by tightening curb radii, which will encourage slower speeds, shorten crossing distances, and improve comfort for pedestrians and bicyclists.

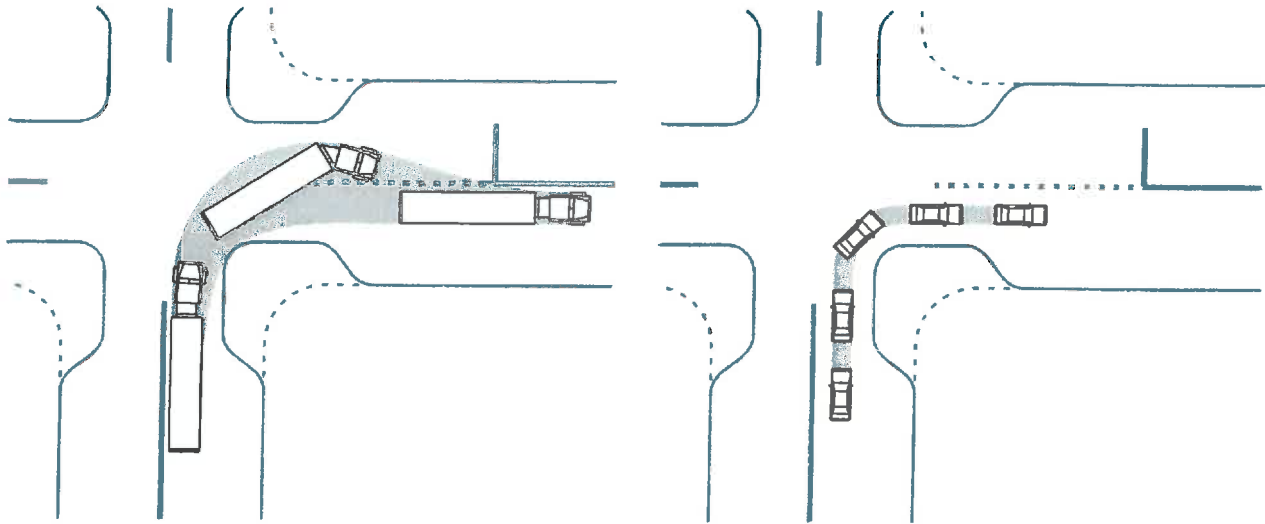

Source: NACTO Urban Street Design Guide (2013)

Effective Radius

Designers should pay special attention to the effective radius of corners. Where vehicles are offset from the curb (by on-street parking or personal mobility lanes, for example), their effective turning radius will be much larger than the radius of the corner. Designers should minimize the effective radius to discourage high-speed turns.

Visibility

Sight Distance

Allowing street users to see each other is essential to safety. Geometric design standards should accommodate required sight distance along vertical and horizontal curves and at intersections; however, changes in the built or natural environment can sometimes limit sight lines, increasing crash risk. Special care should be given to high-volume driveways, ensuring that sufficient sight distance is available to make all allowable movements. Areas where pedestrians stand waiting to cross the street should be visible to motorists and not blocked by signs, trees, poles, or parking.

Lighting

Crash rates are consistently higher under low-light conditions. In addition, lighting can deter crime and make vulnerable road uses feel more safe and secure. Intersection lighting and pedestrian-level corridor lighting are recommended in areas with transit, higher pedestrian and cyclists volumes, or unusual geometric or roadside conditions. Refer to the Traffic Engineering and Operations Manual and APWA 5800 for information on lighting design.

Conflict Points

Conflict points are locations where street users cross paths. These locations hold the potential for severe collisions when users fail to perceive, react to, or obey signs and signals, or when such devices malfunction or are missing. As the number of lanes entering an intersection increases, so do conflict points, and as entering speeds increase, so do crash severities.

Designers should look for opportunities to manage conflict points by limiting right-angle crossing points. Roundabouts, for example, nearly eliminate the possibility of high-speed right-angle collisions and significantly reduce fatal and serious injuries. Features such as raised medians and split signal phasing can also help reduce conflict points, slow drivers down, and make decisions easier for all road users by limiting the number of hazards each person must evaluate before making stay-or-go decisions.

Intersections

Intersections present the most complexity and the greatest number of conflict points for all street users. In the most recent available crash data (2019-2023), crashes at intersections accounted for approximately 64% of all fatal and serious injury crashes in Kansas City. At all intersections, access and safety for the most vulnerable users should be prioritized. Pedestrians and cyclists should be made highly visible to motor vehicles, both through positioning in the driver's field of vision and through appropriate lighting. At higher-volume, higher-speed intersections, mode separation in space or time (such as grade separated pedestrian crossings or pedestrian-only signal phases) may be appropriate.

Motor vehicle speeds should be managed near intersections to reduce the risk of severe crashes with pedestrians and cyclists. Improvements to signs and pavement markings that increase visibility or clarity for users can increase compliance with traffic control. Bike boxes and leading pedestrian intervals establish the presence of vulnerable users to motor vehicle drivers. Raised crosswalks and raised intersections can slow motor vehicles as they approach the intersection and make them more aware of the presence of other users.



Figure 1 – Kansas City Vision Zero intersection improvements at Prospect Avenue and 31st Street. Improvements included high visibility crosswalks, pedestrian refuge islands and curb bump outs.

Pedestrian Crossings

Crossing safety for pedestrians is impacted by distance to the crossing from pedestrian traffic generators, street width, corner radius, sight lines, vehicle volume and speed, lighting, and consistency of driver and pedestrian expectations from one crossing location to the next.

Intersections in residential and neighborhood commercial areas, near schools and churches, near parks and recreation spaces, and in any other area where pedestrians may wish to cross the street should include well-marked crosswalks. Signalized intersections should provide sufficient time for pedestrians to cross the street at a comfortable pace; this pace will be slower for young children, older adults, and people using mobility assistance devices. Restricting right turns on red and using leading pedestrian intervals can help establish the presence of pedestrians and reduce the likelihood of them being struck in designated crossing areas at intersections.

To encourage pedestrians to use safe crossings, designers should take care to provide crossings at a reasonable frequency. Pedestrians often prioritize convenience when choosing a path to cross the street. If intersection crossings are spaced too far apart, pedestrians may choose to ignore them. In urban areas, crossings should generally be provided every 400–600 feet; however, appropriate crossing frequency will vary based on land use and specific pedestrian generators.

In many situations, midblock crossings should be provided. They should include highly visible pavement markings and advanced warning signs. Where volumes and/or speeds are higher, additional treatments, such as an actuated pedestrian signal, pedestrian hybrid beacon (PHB), or rectangular rapid flashing beacon (RRFB) may be appropriate.



Where mid-block crossings cannot be safely provided, consideration can be given to adding median treatments such as tall barriers and fencing that physically prevent or strongly discourage pedestrians from crossing away from intersections or other designated crossings.

Where crossings span multiple lanes in each direction of travel, or where signalization is not provided, a refuge island can improve safety by allowing pedestrians to break their crossing into two stages, which allows them to focus on one direction of approaching traffic at a time.

Pedestrian crossings should connect pedestrian paths; a crossing should never lead a pedestrian to a location without a sidewalk, trail, or multiuse path. However, the lack of pedestrian infrastructure does not suggest a crossing should not be provided—it suggests that additional infrastructure be built to support the pedestrian network.



Lateral Separation of Modes

Many pedestrians and cyclists are uncomfortable near fast-moving vehicles. Often, strategies to shield vulnerable road users from vehicles are limited by a constrained right-of-way. Designers can balance this by considering features that buffer vulnerable users from vehicles.

For example, if the minimum required buffer between curb and sidewalk cannot be provided, the presence of a personal mobility lane or on-street parking might function as a buffer and make a reduced pedestrian buffer more acceptable. Similarly, on-street parking can be used as a buffer between a personal mobility lane along the curb and motor vehicle traffic. Designers should consider the speed of the roadway when selecting buffer types and widths. It is not appropriate to minimize buffer when pedestrians or cyclists are adjacent to high-volume or high-speed traffic.

Visual separation can also increase safety for vulnerable road users. Buffered personal mobility lanes with vertical delineators, for example, will likely be more comfortable than buffered personal mobility lanes without, even if the buffer width remains constant. For sidewalks especially, the buffer area should be visually distinct. If it is not practical to use a grassed/planted buffer, designers should consider alternate materials or, especially if space is restricted, a barrier (such as bollards). Where the full recommended width of sidewalk and buffer cannot be provided, designers should seek to provide some physical and visual buffer, even if it requires some minimal reduction of the sidewalk. As discussed, reducing travel lane width is preferred over reducing sidewalk or personal mobility lane width.

Access Management

Access type and density can vary significantly across street typologies, from limited-access freeways to full-access downtown streets. Street designers should be thoughtful about the placement of access drives, which represent conflict points for all users, especially when uncontrolled or near an intersection. On higher-volume streets, modifying internal traffic circulation, providing shared driveways, or adding access streets can limit or consolidate access points.

Access can be restricted with raised medians in the driveway ("pork chop islands") that limit specific movements or with raised medians in the major road, which can have the same effect while providing refuge for crossing pedestrians and calming adjacent traffic.

Where continuous medians are used, U-turn lanes and roundabouts can provide opportunities for drivers to change directions and access destinations on the other side of the street. While two-way left-turn lanes are acceptable, medians with structured turning movements are preferred. The design should support turning speeds of under 15 mph.

On very low-volume streets, frequent access points can signal to drivers that slower speeds are required to accommodate entering and exiting traffic.

Considerations for Street Designers

Street design should match the context of the roadway, including its users, its relationship to the transportation network, the current and future adjacent land use, nearby population density and demographics, desired aesthetic, and community priorities. The following are important considerations for designers as they make choices.

Connectivity

Connectivity indicates how conveniently and comfortably users can travel to their desired destinations. Accommodation for modes or user groups, such as personal mobility lanes or bus lanes, should not be considered individually for each project, but instead in a coordinated manner across the network. When the transportation system provides a connected and convenient network for each user group, it encourages a stratification of modes that makes it easier to accommodate each of them safely.

As new development occurs, providing multiple routes between origins and destinations will improve the connectivity and resilience of the network. Frequent connections allow for easier mobility when a street is closed, and multiple paths reduce demand on any given route, allowing for fewer lanes.

Timescale

Remaining design life, as well as pavement condition, may impact the types of treatments that are considered for a specific corridor. If a street is likely to be replaced in the short term, temporary improvements may be preferred in the interim. Temporary improvements can be an effective tool to make a street safer while reducing costs. They also provide an opportunity to generate feedback from the public and make adjustments to address any unforeseen concerns before installing permanent infrastructure. The following are common examples of temporary treatments:

- curb corners extended with planters or paint and vertical delineator posts
- prefabricated speed humps and tables
- trailer-mounted speed feedback signs



When estimating trip generation in future years, designers should consider the potential for modal shift away from vehicle trips. The Kansas City Climate Protection and Resiliency Plan includes strategies to shift trips to bicycling, walking, and transit trips by expanding networks for these modes. This Streets Design Guide provides guidance to support the implementation of these strategies.

Wider than necessary streets lead to higher speeds and potentially dangerous conditions for vehicles and vulnerable users. Instead, where growth is anticipated, street designers should purchase right-of-way for the future projected need while restricting the initial street to the fewest lanes needed. The street should be built to one side of the right-of-way to reduce the need to relocate utilities and drainage in the future. Medians

and adjacent shared use paths can be built on the remaining right-of-way until traffic volumes warrant additional lanes.

Level of Service

Level of Service (LOS) has historically been a quantitative assessment of vehicle speed, delay, and congestion. LOS for motor vehicles ranges from A, in which vehicles have minimal delay and can freely travel at or above the speed limit to F, in which vehicles experience “breakdown” congestion (i.e. stop-and-go conditions).

This measure focuses on driver comfort and convenience; however, Level of Service A is associated with a higher crash rate than LOS C or D. Conditions that constrain free flow speed and require drivers to be more attentive when changing lanes or making turning maneuvers can reduce the frequency and severity of crashes. Moderate traffic flows with limited speeds (LOS C and D) tend to have the lowest crash rates.

Research conducted for Kansas City’s Vision Zero Action Plan shows the relationship between congestion and fatal and serious injury crash risk. Streets with lower volume-to-capacity ratios were consistently more likely to experience fatal and serious injury crashes.

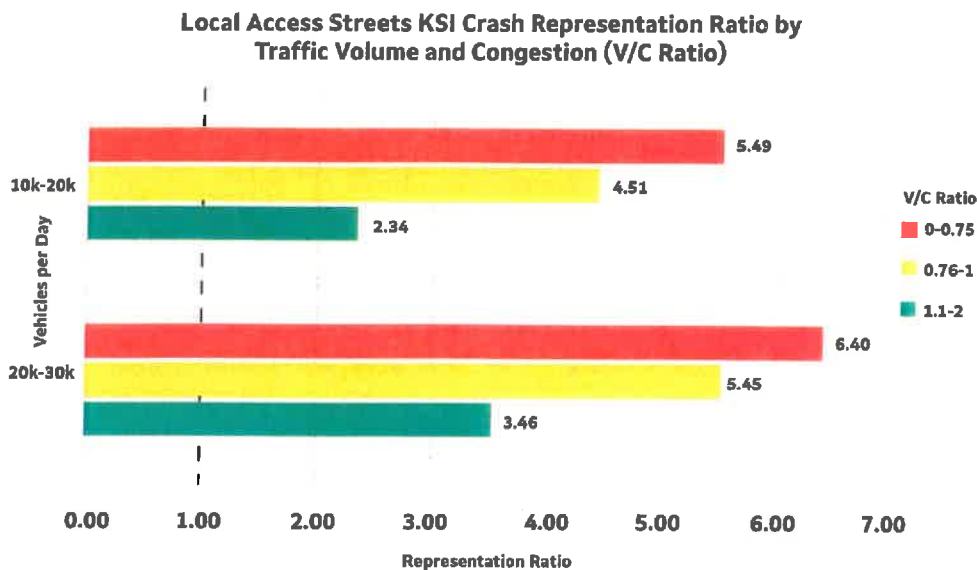

Figure 2 – Crash Representation Ratio by V/C Ratio (See KCMO VZ Action Plan Page 47)

Newer metrics such as Pedestrian Level of Service (PLOS) and Bicycle Level of Service (BLOS) can measure the comfort and convenience of other user groups. The Level of Service of Safety (LOSS) is a measure of a street’s safety performance, comparing its observed crash history to predicted crashes for a street with similar characteristics. To meet City Vision Zero and Complete Streets goals, **these measures should take precedence on City streets over the traditional LOS measure for motor vehicles.** Additional guidance for determining LOS for all modes is provided in Sections 2.3 and 2.4 of the Highway Capacity Manual and the Federal Highway Administration (FHWA) Guidebook for Developing Pedestrian and Bicycle Performance Measures.

In addition to these quantitative metrics, designers should use surveys, walk audits, and other

engagement strategies (either in coordination with a project or on a regular basis) to provide insight into the experience of street users and to improve a street's perceived level of service.

Human Factors

How well a street operates is determined by how well users understand and comply with its intended use. Human factors describe how roadway users perceive and react to information in their environment and are impacted by sight distance; lighting; sign spacing, size, and reflectivity; marking visibility, placement, and design; clear zone width; fixed object type and density; speed and volume of traffic; and other elements of the roadway environment.

Especially at complex intersections, street designers should take care to minimize driver workload and maximize clarity of expectations. Best practices include providing sufficient sight distance, proper lighting, retroreflective signs and markings, wayfinding guidance, and consistency in street cross-section and traffic control.

In other locations with lower complexity—where drivers can be prone to inattentive driving—it may be helpful to introduce elements that require drivers to pay more attention to their speed. Signs and striping can be used to make drivers more aware of their speed in relation to the roadway context. Design elements like lane shifts, pinch points, and mini roundabouts can be used on low-speed routes to help drivers maintain focus.

Equity

The Kansas City, Missouri (KCMO) Vision Zero Action Plan identifies clear inequity in the transportation system, especially with respect to safety. Black residents face the highest risk of death and serious injury on Kansas City streets.

Historically, disadvantaged communities have been disrupted or destroyed by the development of the transportation system. These populations are still exposed to streets that endanger vulnerable users and adversely affect their health with noise and pollution. In response, street designers must take special care to include neglected perspectives and consider how the costs and benefits of their project are distributed.

Land Use and Placemaking

The development surrounding a corridor defines the purpose and activity of the street. The density of development increases as you move from rural areas with large lots and low activity; through suburban areas with higher activity and single use development; and into the urban core with high levels of street activity, mixed use developments, and shorter block lengths. These factors influence modes of travel and uses of the public right-of-way.

Streets contribute to a sense of place. Landscaping, human-scale lighting, art, and furniture along the street can add value to adjacent development. By contrast, harsh lights, noise, and high vehicle speeds can depress value. Street design tells users who is welcome and can support or discourage foot traffic, bicycling, recreational trips, and deliveries. Pleasant streets for all users are economic engines: they attract customers and connect businesses to the freight network.

Sustainability and Climate Resilience

More than 30% (2.9 million MTCO₂) of Kansas City's greenhouse gas emissions come from motor vehicles. The City's Climate Protection and Resiliency Plan established multiple goals regarding mobility, including:

1. Reducing vehicle miles traveled
2. Shifting trips to lower emissions options
3. Reducing idling and congestion
4. Increasing transit trips

Designers should approach street projects with a sustainability focus. Broadly, streets should be designed to promote more transit, walking, and bicycle trips to improve local air quality. On a smaller scale, individual devices (for lighting, signaling, etc.) should use solar power where possible. During construction, designers should seek opportunities to preserve pavement and incorporate recycled materials.

Street designers should also consider how each street interfaces with natural systems, including weather, wildlife, and environmental landmarks. It is increasingly important that our infrastructure is resilient to both acute natural disasters and more gradual changes in climate. Kansas City expects increasing rainfall volumes, which will further tax the existing combined sewer infrastructure and worsen water quality. Kansas City also expects higher average temperatures and more frequent heat waves.

A key component of resiliency is green stormwater infrastructure. Designers can use simple strategies (such as curb cuts or trench drains) to bring water that would otherwise be treated as waste to street trees and native landscaped areas. Additionally, larger excavations, improved soil media, and proprietary soil cell systems will enhance the health and longevity of street trees. Landscaped areas also help to reduce urban heat island effects. Green stormwater infrastructure may also be referred to as post-construction stormwater, best management practices, stormwater control measures, nature-based solutions, or stormwater treatment facilities.

The City of Kansas City, Missouri, established a Climate Protection and Resiliency Plan in 2022. Several strategies included in the plan can be achieved through pursuing complete street design such as expanding the network of trees (Strategy N-1) and using natural systems to manage stormwater runoff (Strategy N-4). Street features that manage water—including swales and planted elements—can make the street more attractive while managing increased rainfall. Where possible, street designers should minimize the use of impervious surfaces. Both strategies build resilience to extreme heat and flooding.

CLIMATE ACTION SECTIONS AND STRATEGIES



MOBILITY

- M-1: Reduce vehicle miles traveled (VMT) through coordinated and planned development
- M-2: Shift trips to bicycling and walking by expanding a network of safe and accessible routes
- M-3: Shift trips to transit by building efficient and effective transit systems and mobility hubs
- M-4: Reduce vehicle emissions from idling by reducing congestion and improving parking management
- M-5: Reduce vehicle emissions through low- and no-emission vehicles

Source: KCMO Climate Protection & Resiliency Plan

Street Typologies

Street typologies are categories used to define streets by their function, design and usage. This section provides the definitions, characteristics and cross sections for the following street typologies:

- Downtown Core
- Urban Mixed Use
- Suburban Commercial
- Thoroughfare
- Connector
- Neighborhood
- Industrial / Business Park
- Boulevards
- Parkways

The street typologies in this section of the Streets Design Guide correspond to an online, interactive Streets Design Guide Map, which assigns each street in Kansas City to a typology. This map can be found on the City's website at [\[PLACEHOLDER URL\]](#)

Each street typology will have a unique approach to the allocation of space. While the building environment limits the available right-of-way, the existing right-of-way can be redistributed to satisfy the changing needs of a community or neighborhood.

When considering how to allocate available right-of-way, the priority is the safety of vulnerable road users because pedestrians and cyclists are more vulnerable to serious injuries than drivers when involved in a crash. The next is accommodating other user groups in accordance with established personal mobility (bike) and transit networks. This can sometimes mean reducing the number or width of standard travel lanes to provide pedestrian space, personal mobility lanes, transit lanes, or medians.

When allocating right-of-way, City goals of reducing traffic fatalities, reducing carbon emissions by encouraging mode shift to reduce miles traveled by single-occupancy passenger cars, and increasing healthy communities should be prioritized.

The space adjacent to street curbs can be used for motor-vehicle parking, ride-share loading and unloading, transit stops, bikeshare parking, electric vehicle charging, deliveries, green stormwater infrastructure, and public spaces like street cafes. Each of these amenities can contribute to access, placemaking and safety. Decisions about curbside management should be made to align with the street typology and adjacent development, providing flexibility to allow changes as needs change. Motor vehicle traffic should be slower near areas with heavy curbside activities and these zones should be made visible to approaching traffic.

Elements of Design

Each typology provides a table of key characteristics. Definitions for these characteristics and other terms included in this section are defined in the table below.

Target Speed	The highest speed at which vehicles should operate in a specific context. Target speed, design speed, and posted speed should be equal.
Design Vehicle	The largest vehicle that is likely to use the facility with considerable frequency, whose selection will determine road geometry. See the following page for examples of design vehicles.
Control Vehicle	The largest vehicle that will infrequently use the street.
Right-of-Way Width	Public space designated for travel. On established streets, this space is typically fixed. For new construction, designers should refer to the recommended ranges for a particular typology.
Lane Width	The width of travel lanes.
Pedestrian Facilities	Pedestrian facilities, generally known as the sidewalk, is the space allocated for pedestrians between the street curb and the edge of the right-of-way, which includes both the pedestrian and amenity zone. The "pedestrian zone" space is allocated to unobstructed pedestrian through movement. The "amenity zone" includes landscaping, green infrastructure, utilities, transit stops, loose furnishings or street furnishing zone in the area between the street and the "pedestrian zone."
Curbside Uses	Utilities, amenities, landscaping, transit stops, or green stormwater infrastructure that occupy the curbside use within the roadway space occupied by vehicles.
Micromobility Facilities	Space allocated for the operation of bicycles and other micromobility devices (scooters, etc.), which may be separated from or shared with motor vehicles and other modes.
Transit Facilities	Space allocated for transit services, either within the roadway or at the curb.
# of Travel Lanes	The number of lanes for vehicle through movement.
Parking	Space within the ROW allocated for motor vehicle parking. This may include parallel, angled, reverse-angled (preferred to angled), or traffic lanes designated for parking during certain days/times.
Green Stormwater Infrastructure	A holistic approach to stormwater management that collects and stores rainwater where it falls by mimicking the natural water cycle. Guidance for stormwater infrastructure is in the KCMO Green Stormwater Design Guide. Trees and landscaping present can help reduce the urban heat island effect.
Street Activation	The level of activity between pedestrians and buildings along the street.
Place Type	The land use character typically adjacent to the street.
Access Control	Restrictions on driver movements, especially with driveways that intersect the street. This may also include raised medians or signage.

Street Typology	Vehicle Type
-----------------	--------------

Neighborhood
Boulevards
Parkways

DL-23

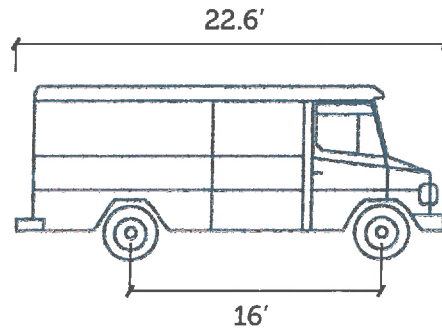

Source: NACTO

Downtown Core
Urban Mixed Use
Suburban Commercial
Thoroughfare
Connector

SU-30

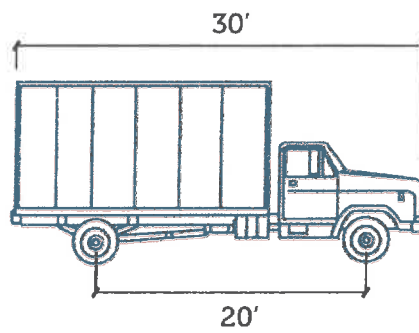

Source: NACTO

Industrial / Business Park

WB-50

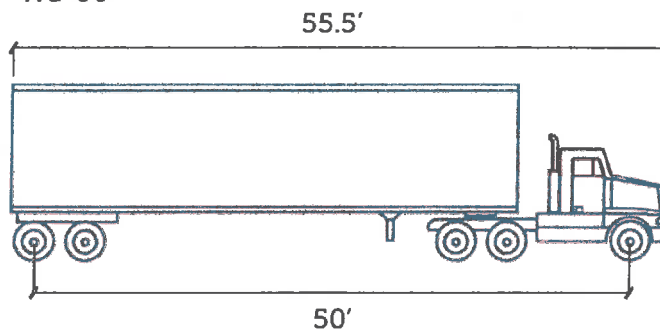

Source: NACTO

Downtown Core

Downtown Core streets fall within areas of high development density such as a central business district. They accommodate low motor vehicle speeds, high pedestrian volumes, enhanced transit connections, and freight delivery activity. See Area Plans areaplans.kcmo.gov and KC Spirit Playbook for more information.

Many downtown core streets have been studied in the past. These previous studies should be heavily considered when looking at those particular streets. Here is a list of known studies that represent downtown core streets.

- River Market streetscape plan
- West Bottoms
- Downtown Loop streetscape plan
- Two-way conversion study 2024 – 7th Street, 8th Street, 9th Street, 10th Street
- Grand Boulevard - Making Grand Grand - 2011

Downtown Core Example Streets

Most streets within the downtown loop fit in the Downtown Core typology, including:

- 10th Street
- 11th Street
- 12th Street
- 13th Street
- 14th Street
- Oak Street
- Walnut Street
- Main Street
- Baltimore Avenue
- Wyandotte Street
- Central Street

Downtown Core Key Characteristics

Target Speed	20 mph
Design Vehicle	SU-30
Control Vehicle	Aerial Fire Truck MM100
Right-of-Way Width	50'–100'
Lane Width	11' or 10' if no bus in the lane
Pedestrian Facilities	Pedestrian zone - 10'+ sidewalk preferred, 6' minimum, amenity zone - 4' minimum.
Curbside Uses	Loading zones, pedestrian amenities, bicycle parking, transit stops
Micromobility Facilities	Sharrows allowed under 15 mph / standard personal mobility lanes < 6,000 vpd / buffered or separated lanes ≥ 6,000 vpd, separate from sidewalk space
Transit Facilities	Transit service is very likely on Downtown Core streets. Refer to "Accommodation for Transit Vehicles" under Design Guidance.
# of Travel Lanes	2 for streets < 20,000 vpd, otherwise 4
Parking	<p>On-street parking is allowed, both full-time and off-peak. Parking rates should be charged to encourage turnover. Reverse-angled parking is preferred, but angled or parallel parking is also allowed. Angled parking must be reverse-angle on one-way streets.</p> <p>Freight vehicles often use street space for unloading on downtown core streets. If only two travel lanes are provided, designers should designate parking space for freight unloading.</p>
Green Stormwater Infrastructure	Native plantings in buffer areas or medians and street trees. Rain gardens in curb extensions or combined with street furniture
Street Activation	High level of street activation including heavy pedestrian, bicycle, and shared mobility travel; street vendors, street cafes; and parklets.
Place Type	Downtown Core, Downtown Mixed Use
Access Control	Driveways should be heavily restricted. Drive aprons shall be designed at their minimum width.

DOWNTOWN CORE

This conceptual roadway diagram illustrates a range of possible segments for the given street typology and is not intended to represent a continuous roadway condition.



- 1 HIGH VISIBILITY CROSSWALK**
A crosswalk that provides increased visibility to motorists through high-visibility pavement, markings, lighting, and bollards.
- 2 TWO-WAY CYCLE TRACK**
Separated bike lanes that allow bicycle movements in both directions on one side of the street.
- 3 PROTECTED BIKE LANE**
Protected mobility lanes that provide a physical barrier between bicycle and vehicle traffic. Vertical elements like concrete curbs also provide a visual barrier.
- 4 PROTECTED INTERSECTION**
Intersections that provide separate paths for cyclists, pedestrians, and vehicle traffic and that provide physical protection, improve visibility, and reduce crossing distance for bicyclists.
- 5 PEDESTRIAN REFUGE ISLAND**
A median with a refuge area that provides pedestrians a protected area to cross a multi-lane road in two stages if necessary.
- 6 PARKLET**
Public seating to inform the public. Convert curbside parking spaces into outdoor dining and/or community space. These are often used to provide additional space in the pedestrian realm.
- 7 TRANSIT**
Dedicated transit lanes that improve throughput of buses and reduce vehicle weaving on corridors. These lanes may sometimes be shared by cyclists and/or other turn vehicles. Bus stop areas and appropriate along transit lanes.
- 8 CURB EXTENSIONS**
Curbs extended into the street, either with concrete or paint, at crossing locations to reduce the crossing distance for pedestrians, making pedestrians more visible to motorists and provide space for street furniture, lighting, trees, and traffic signal equipment.
- 9 RAISED CROSSWALK**
Crosswalks that are elevated, similar to a speed hump or curb, that limit turning speed of vehicles and increase the visibility of crossing pedestrians.

Downtown Core Cross Section Options



80-foot ROW: Two-way segment with center turn lane, parking lanes, and separated mobility lane on both sides



60-foot ROW: One-way segment with transit-only lane and separated two-way mobility facility

Downtown Core Cross Section Options



60-foot ROW: Two-way segment with parking

Urban Mixed-Use

Urban Mixed-Use streets are neighborhood-level commercial corridors outside of the central business district providing access to high-level trip generators such as retail, office, and restaurant space. These areas have a defining character and typically have a historic significance for the local community. The corridors are typically dense and walkable.

Urban Mixed-Use Example Streets

- 63rd Street between Wornall Road and Troost Avenue
- 39th Street from State Line Road to Gillham Road
- 31st Street from Oak Street to Troost Avenue
- 75th Street between Pennsylvania Avenue and Main Street

Urban Mixed-Use Key Characteristics

Target Speed	25 mph
Design Vehicle	SU-30
Control Vehicle	Aerial Fire Truck MM100
Right-of-Way Width	80'–120'
Lane Width	10' minimum; 11' when bus is present in that lane
Pedestrian Facilities	Pedestrian zone - 10'+ sidewalk preferred, 6' minimum, amenity zone - 4' minimum.
Micromobility Facilities	Buffered or separated lanes, separate from sidewalk space
Curbside Uses	Pedestrian amenities, bicycle parking, transit stops, landscaping
Transit Facilities	Transit service is very likely on Urban Mixed-Use streets. Refer to "Accommodation for Transit Vehicles" under Design Guidance.
# of Travel Lanes	2 for streets < 20,000 vpd, otherwise 4
Parking	On-street parking is allowed, both full-time and off-peak. Parking rates should be charged to encourage turnover. Reverse-angled parking is preferred, but angled or parallel parking is also allowed.
Green Stormwater Infrastructure	Native plantings in buffer areas or medians and street trees. Rain gardens in curb extensions or combined with street furniture
Street Activation	High level of street activation including heavy pedestrian, bicycle, and shared mobility travel; street vendors, street cafes; and parklets.
Place Type	Commercial, Mixed-Use Community, Mixed-Use Neighborhood, Mixed-Use Neighborhood, Mixed-Use Residential, Regional Center (RC), Community Center (CC), Neighborhood Center (NC)
Access Control	Driveways should be minimized by promoting local access roads, shared drive access, right-in/right-out only, and/or minor street access. Access for major generators should be evaluated for appropriate traffic control treatments. Drive aprons shall be designed at their minimum width.

URBAN MIXED USE

This conceptual roadway diagram illustrates a range of possible segments for the given street typology and is not intended to represent a continuous roadway condition.

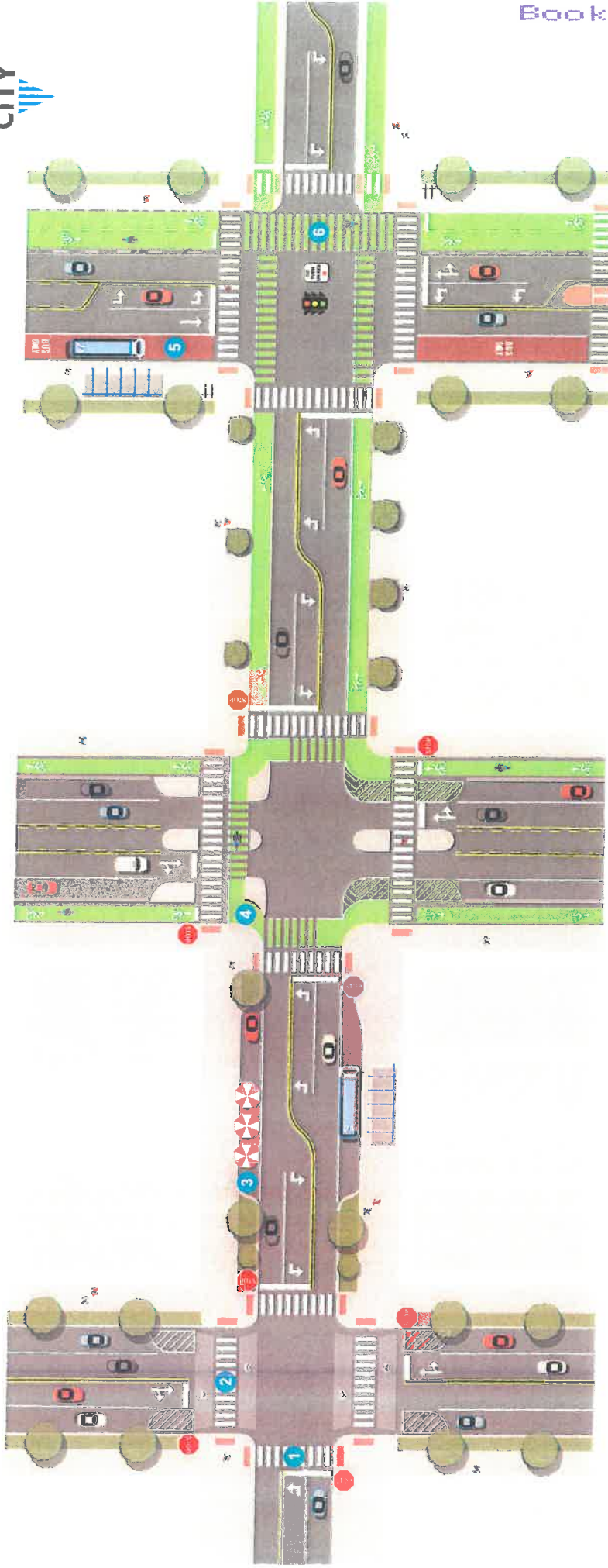

1 HIGH VISIBILITY CROSSWALK
Using contrastive crosswalk markings increases the visibility of a crosswalk to motorists.

2 RAISED CROSSWALK
Raised crosswalks limit turning speeds of vehicles and increase the visibility of crossing pedestrians.

3 PARKLET
Public seating platforms that convert curbside parking spaces into lounge, dining, and/or community space. These are often used to accommodate needed space in the pedestrian realm.

4 PROTECTED INTERSECTION
Protected intersections provide physical separation between cyclists and vehicle traffic, improving sightlines, reducing crossing distances and providing predictable movement through an intersection.

5 TRANSIT
Dedicated transit lanes that improve throughput of buses and reduce vehicle weaving on corridors. These lanes may sometimes be shared by bicyclists and/or right turn vehicles. Bus and/or bike lanes appropriate along transit lanes.

6 BIKE INTERSECTION MARKINGS
Green painted crossing that increase the awareness of motorists that bicyclists may cross at this location. These markings also provide wayfinding for bicyclists.

Urban Mixed-Use Cross Section Options



80-foot ROW: Two-way segment with center turn lane, parking lane on one side, and separated mobility lane on both sides

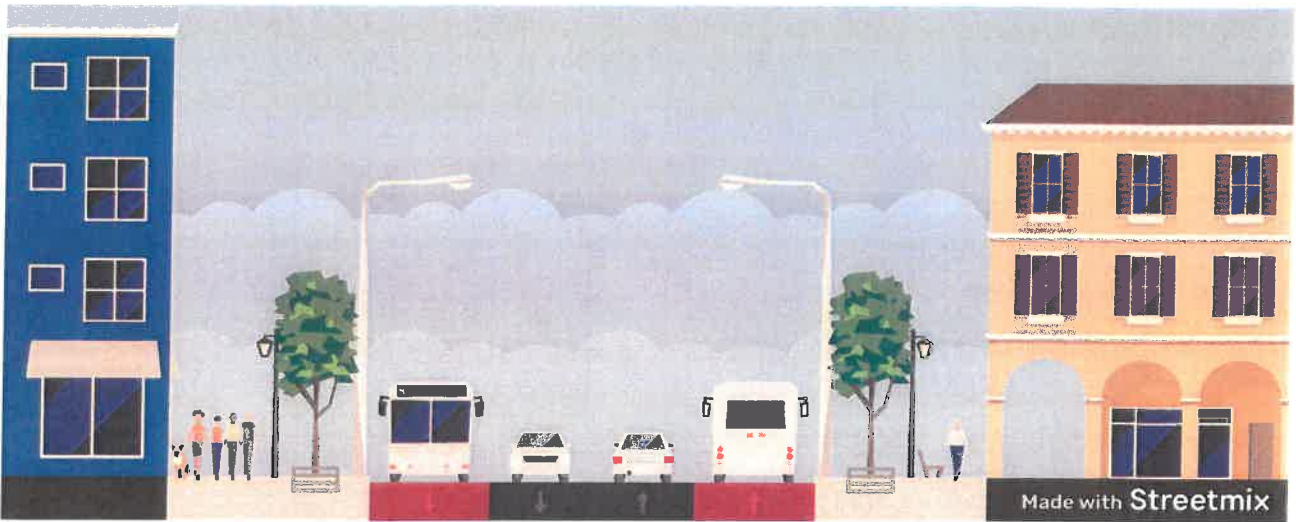

80-foot ROW: Two-way segment with transit-only lane on both sides

Urban Mixed-Use Cross Section Options



60-foot ROW: Two-way segment with center turn lane



60-foot ROW: Two-way segment with parking lane on both sides

Suburban Commercial

Suburban commercial streets are heavy commercial corridors with standard suburban style commercial development. This may include malls, strip retail centers, drive-thru restaurants, gas/oil/tire stations, car washes, and other businesses.

Suburban Commercial Example Streets

- NW Prairie View Road
- N Ambassador Drive
- N Boardwalk Avenue
- N Oak Trafficway
- Wyandotte, Washington Street and Madison Avenue in Martin City

Suburban Commercial Key Characteristics

Target Speed	25 mph
Design Vehicle	SU-30
Control Vehicle	Standard Pump Fire Truck
Right-of-Way Width	80'–120'
Lane Width	10' minimum; 11' when bus is present in that lane
Pedestrian Facilities	Pedestrian zone - 10' minimum, amenity zone - 4' minimum and is typically green space.
Curbside Uses	Landscaping, wayfinding, and transit stops
Micromobility Facilities	Separated mobility lanes with a preference for being at sidewalk level. Shared use path with 12' width preferred.
Transit Facilities	Transit service is possible on Suburban Commercial streets. Refer to "Accommodation for Transit Vehicles" under Design Guidance.
# of Travel Lanes	2 for streets < 20,000 vpd, otherwise 4
Parking	No on-street parking
Green Stormwater Infrastructure	Native plantings in buffer areas and street trees placed behind the sidewalk
Street Activation	Low
Place Type	Open Space/Buffer, Commercial, Mixed Use Community, Mixed Use Neighborhood, Mixed Use Residential, Residential High, Residential Medium, Residential Low, Business Center (BC, IF, CC, NC, N3, N2)
Access Control	Driveways should be minimized by promoting local access roads, shared drive access, right-in/right-out only, and/or minor street access. Access for major generators should be evaluated for appropriate traffic control treatments. Drive aprons shall be designed at their minimum width.

SUBURBAN COMMERCIAL

This conceptual roadway diagram illustrates a range of possible segments for the given street typology and is not intended to represent a continuous roadway condition.

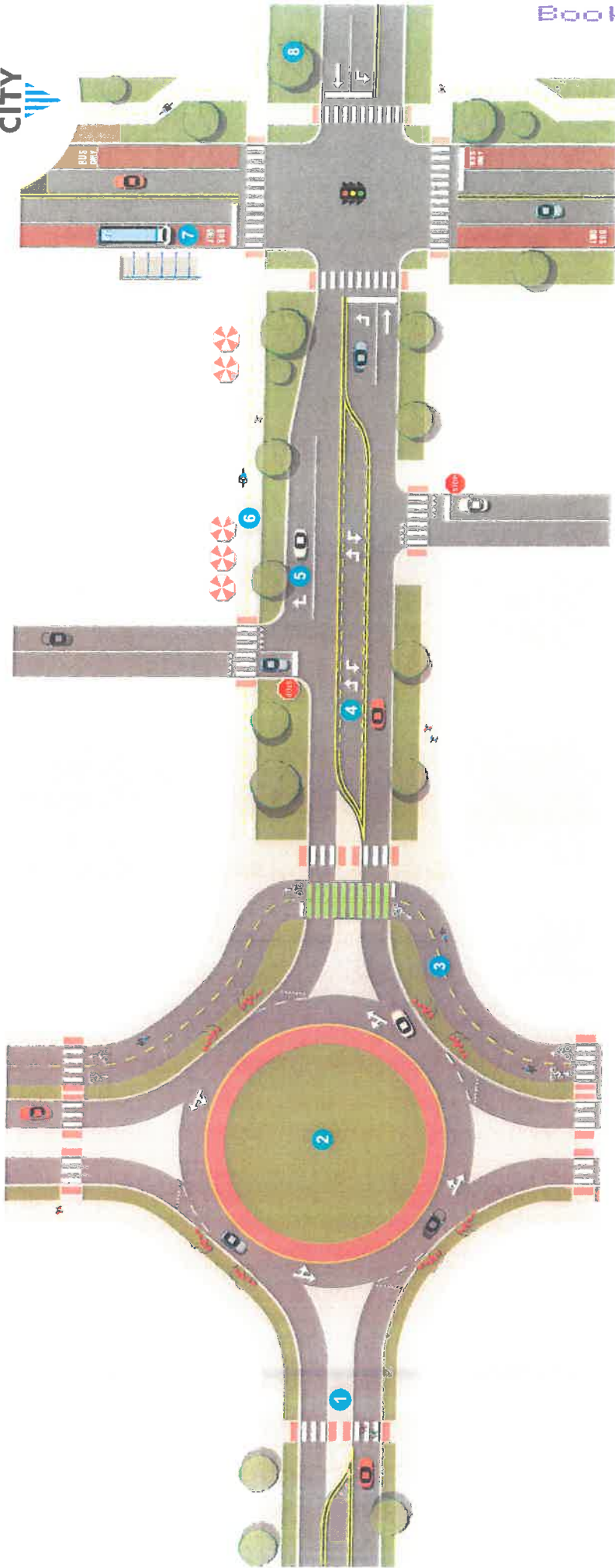

- 1 PEDESTRIAN REFUGE ISLAND**
A median with a refuge area that provides a pedestrian crossing area to cross a multi-lane road in two stages, if necessary.
- 2 ROUNDABOUT**
Circular intersection that reduces vehicle speeds, improves traffic flow, and lowers the risk of serious non-angle collisions compared to traditional intersection.
- 3 TWO-WAY CYCLE TRACK**
Separated bike lanes that allow bicycle movements in both directions on one side of the street.
- 4 TWO-WAY LEFT-TURN LANE**
Center lane that provides separation between left-turning traffic and through traffic in areas with high density or access points. Allows drivers to make turns in two stages and wait in appropriate gaps.
- 5 RIGHT-TURN LANE**
Auxiliary lane that provides space for right-turning vehicles to slow before turning onto a side street or driveway. Can reduce rear-end crashes.
- 6 SHARED USE PATH**
A wide path, designed for pedestrians, cyclists, and other non-motorized travelers that promotes safe, active transportation away from traffic.
- 7 TRANSIT**
Dedicated transit lanes that improve throughput of buses and reduce vehicle weaving on corridor. These lanes may sometimes be shared by bicyclists and/or light duty vehicles. Bus shelters are allowable along transit lanes.
- 8 WIDE BUFFER AREA**
The shoulder and green space provides a wide buffer between heavy vehicles and pedestrians and cyclists.

Suburban Commercial Cross Section Options



100-foot ROW: Two-way segment with median and protected two-way mobility lanes



120-foot ROW: Two-way segment with median and transit facilities on both sides

Suburban Commercial Cross Section Options



120-foot ROW: Two-way segment with center turn lane and separated two-way mobility lanes



100-foot ROW: Two-way segment with parking lane on both sides

Thoroughfare

Thoroughfares are longer corridor streets that connect major areas with limited access. They serve through trips and generally meet the definition of arterials.

Thoroughfare Example Streets

- Bannister Road East of I-435
- Troost Avenue South of 75th Street
- 63rd Street Trafficway east of Swope Parkway
- Southwest Trafficway
- NE Antioch Road

Thoroughfare Key Characteristics

	Typical	Rural Context
Target Speed	30 mph	40–50 mph, depending on access density
Design Vehicle	SU-30	Same
Control Vehicle	Standard Pump Fire Truck	Same
Right-of-Way Width	100'–120'	50'–80'
Lane Width	11'; 12' when used by heavy trucks	Same
Pedestrian Facilities	Pedestrian zone - 10' Amenity zone - 5-8' minimum and is typically green space	Shared use path
Curbside Uses	Landscaping, wayfinding, and transit stops	NA
Micromobility Facilities	Separated mobility lanes	Shared use path
Transit Facilities	Transit service is likely on Thoroughfare streets. Refer to "Accommodation for Transit Vehicles" under Design Guidance.	N/A
# of Travel Lanes	2 for streets < 20,000 vpd, otherwise 4	Same
Parking	No on-street parking	Same
Green Stormwater Infrastructure	Native plantings in buffer areas and street trees placed behind the sidewalk	Ditch
Street Activation	Low	Very Low
Place Type	Light Industrial, Commercial (IF, BC)	Agricultural
Access Control	Driveways should be minimized by promoting local access roads, shared drive access, right-in/right-out only, and/or minor street access. Access for major generators should be evaluated for appropriate traffic control treatments. Drive aprons shall be designed at their minimum width.	Access points should be provided where adequate site distance exists.

THOROUGHFARE

This conceptual roadway diagram illustrates a range of possible segments for the given street typology and is not intended to represent a continuous roadway condition.



1 HIGH VISIBILITY CROSSWALK

A crosswalk that provides increased visibility to motorists through high-visibility pavement markings, signage and lighting.

2 SEPARATED BICYCLE FACILITIES

Bike lanes that are physically divided from vehicular traffic offering a safer and more comfortable experience for cyclists.

3 ROUNDABOUT

Circular intersection that reduces vehicle speeds, improves traffic flow and lowers the risk of serious right-angle collisions compared to traditional intersections.

4 CURB EXTENSIONS

Curbs extended into the street, either with concrete or plant, at crossing locations to reduce the crossing distance for pedestrians, make pedestrians more visible to motorists, and provide shade of street furniture, lighting fixtures, and traffic signal equipment.

5 TRANSIT

Dedicated transit lanes that improve throughput, reduce vehicle weight on corridors, these lanes may sometimes be shared by bicycles and/or right turn vehicles, but shelter are appropriate along transit lanes.

Thoroughfare Cross Section Options



100-foot ROW: Two-way segment with parking lane on both sides and separated two-way mobility lanes

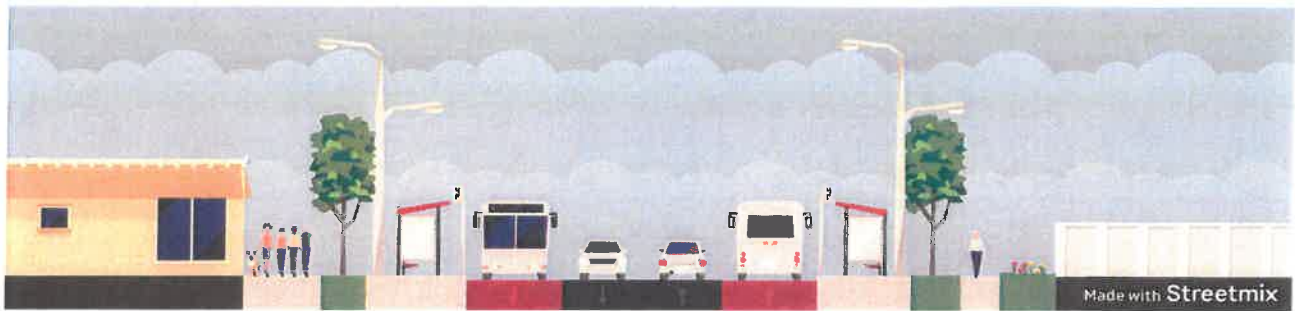

100-foot ROW: Two-way segment with transit-only lane on both sides

Thoroughfare Cross Section Options



100-foot ROW: Two-way segment with transit-only lane on both sides and separated mobility lane on both sides

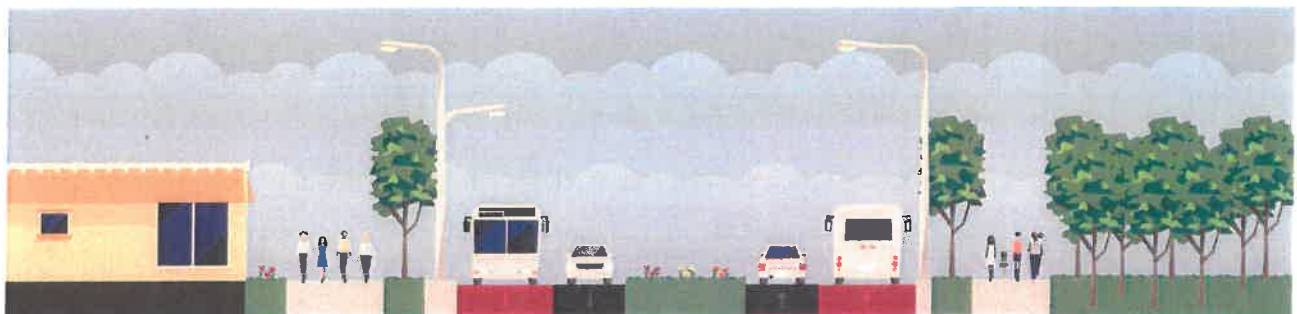

100-foot ROW: Two-way segment with wide median with transit-only lane on both sides

Connector

Connectors are streets focused on access to individual lots and neighborhood streets. They serve destination trips and generally align with the definition of collectors.

Connector Example Streets

- 22nd Street
- 59th Street
- 85th Street
- Holmes Road
- Rockhill Road
- Main Street south of the Plaza
- NW Waukomis Drive

Connector Key Characteristics

	Typical	Rural Context
Target Speed	25 mph	35 mph
Design Vehicle	SU-30	Same
Control Vehicle	Standard Pump Fire Truck	Same
Right-of-Way Width	90'-100'	54'-90'
Lane Width	10' minimum; 11' when bus is present in that lane	10' minimum. 11' when trucks are present
Pedestrian Facilities	Pedestrian zone - 10' preferred, 6' minimum Amenity zone - 5-8'	Paved Shoulder
Curbside Uses	Landscaping, wayfinding, and transit stops	N/A
Micromobility Facilities	Traditional personal mobility lanes allowed under 20 mph / buffered lanes < 6,000 vpd / separated lanes ≥ 6,000 vpd	Paved Shoulder
Transit Facilities	Transit service is possible on Connector streets. Refer to "Accommodation for Transit Vehicles" under Design Guidance.	N/A
# of Travel Lanes	2 for streets < 20,000 vpd, otherwise 4	Same
Parking	No on-street parking	Same
Green Stormwater Infrastructure	Native plantings in buffer areas or medians and street trees placed behind the sidewalk	Ditch
Street Activation	Medium	Very Low
Place Type	Mixed Use Neighborhood, Mixed Use Residential, Residential High, Residential Medium, Residential Low, Conservation District (NC, N3, N2, N1)	Residential Agricultural
Access Control	Driveways should be managed for appropriate intersection distance and sight lines.	Same

CONNECTOR

This conceptual roadway diagram illustrates a range of possible segments for the given street typology and is not intended to represent a continuous roadway condition.

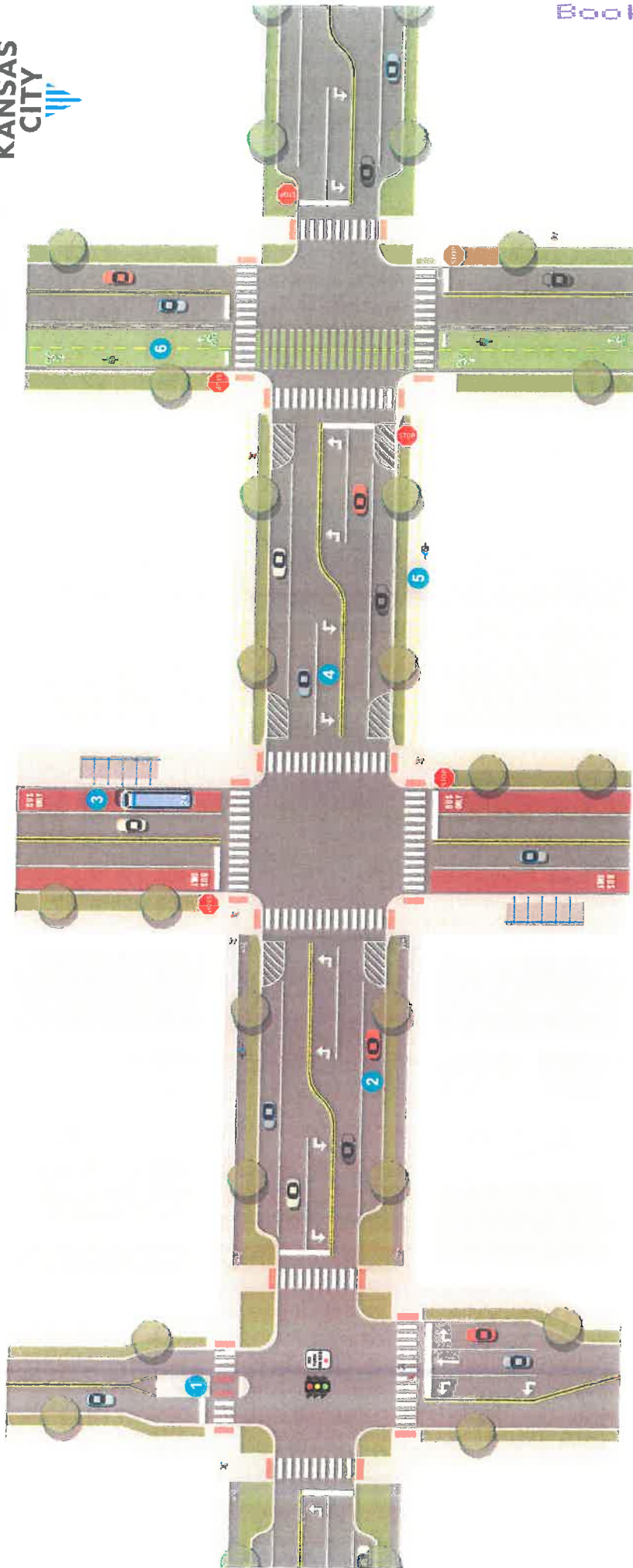

1 PEDESTRIAN REFUGE ISLAND

A median with a refuge area that provides pedestrians a protected area to cross a multi-lane road if two stages of crossing are necessary.

2 ON-STREET PARKING

Lane adjacent to traffic for parking that provides convenience access to nearby destinations, helps slow traffic, and serves as a buffer between motor vehicles and sidewalk users.

3 TRANSIT

Dedicated transit lanes that improve throughput of buses and reduce vehicle weaving on corridors. These lanes may sometimes be shared by bicycles and/or right turn vehicles. Bus shelters are appropriate along transit lanes.

4 LEFT-TURN LANE

Dedicate a lane on an intersection approach that separates left-turning vehicles from through traffic. Which reduces left-turn crashes.

5 SHARED USE PATH

A wide path designed for pedestrians, cyclists, and other non-motorized travelers that promotes safe active transportation away from traffic.

6 TWO-WAY CYCLE TRACK

Separated bike lanes that allow bicycle movement in both directions on one side of the street.

Connector Cross Section Options



60-foot ROW: Two-way segment with separated mobility lane on both sides

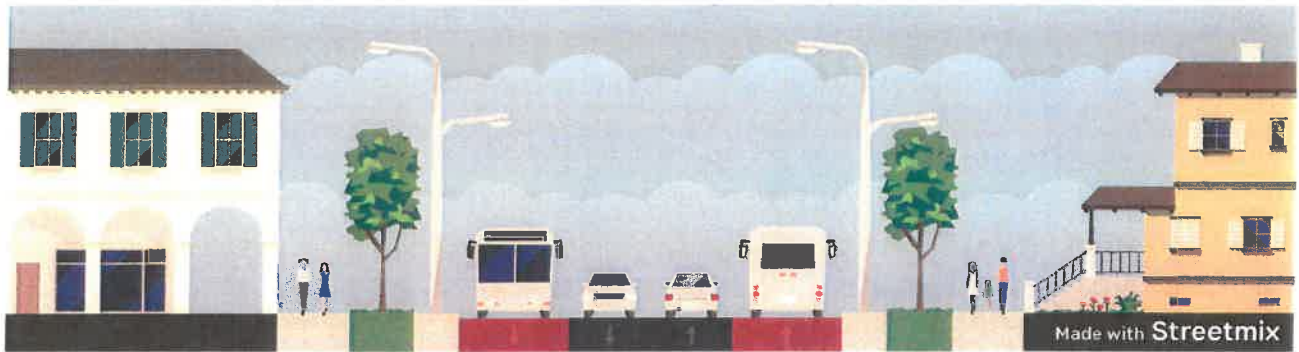

80-foot ROW: Two-way segment with dedicated transit-only lane on both sides



60-foot ROW: Two-way segment with parking lane on one side

Neighborhood

Neighborhood streets are typically residential or local streets. They are lined with single family homes, low-density multifamily homes and corner stores. They have low traffic volumes and speeds, direct interaction with the roadway by users of all ages, and integrated mobility uses.

Neighborhood Example Streets

- Almost all Terrace streets
- Charlotte Street
- Woodbridge Lane
- NW Oakcrest Drive
- N Strathberry Avenue

Neighborhood Key Characteristics

	Typical	Rural Context
Target Speed	20 mph	25 mph
Design Vehicle	DL-23	Same
Control Vehicle	Standard Pump Fire Truck	Same
Right-of-Way Width	46'–54'	40'–60'
Pavement Width	28' minimum when parking is permitted; 22' minimum if no parking is permitted	Same
Pedestrian Facilities	5' minimum sidewalk on both sides of the street, or 8' minimum shared use path on one side of the street. If no sidewalks on a street are installed at the time of development, pedestrian facilities will not be provided by the City for a minimum of 50 years. The amenity zone should be 4-8.'	None
Curbside Uses	Landscaping	N/A
Micromobility Facilities	Personal mobility lanes on high usage mobility routes, sharrows, or none	None
Transit Facilities	Transit service is not likely on Neighborhood streets.	N/A
# of Travel Lanes	Travel lanes are typically not designated. Designers should limit travelway width where possible, especially if on-street parking is not provided.	Same
Parking	On-street parking where street width allows	Same
Green Stormwater Infrastructure	Landscaping and street trees	Ditch
Street Activation	High	Low

Some Neighborhood streets are “unimproved”—these are typically former rural roads which have been annexed into the City but still lack sidewalk or curb and gutter. These streets generally pose a very low safety risk. Unless they are fully reconstructed, it is not necessary that they be improved to the specifications of this typology.

NEIGHBORHOOD



This conceptual roadway diagram illustrates a range of possible segments for the given street typology and is not intended to represent a continuous roadway condition.

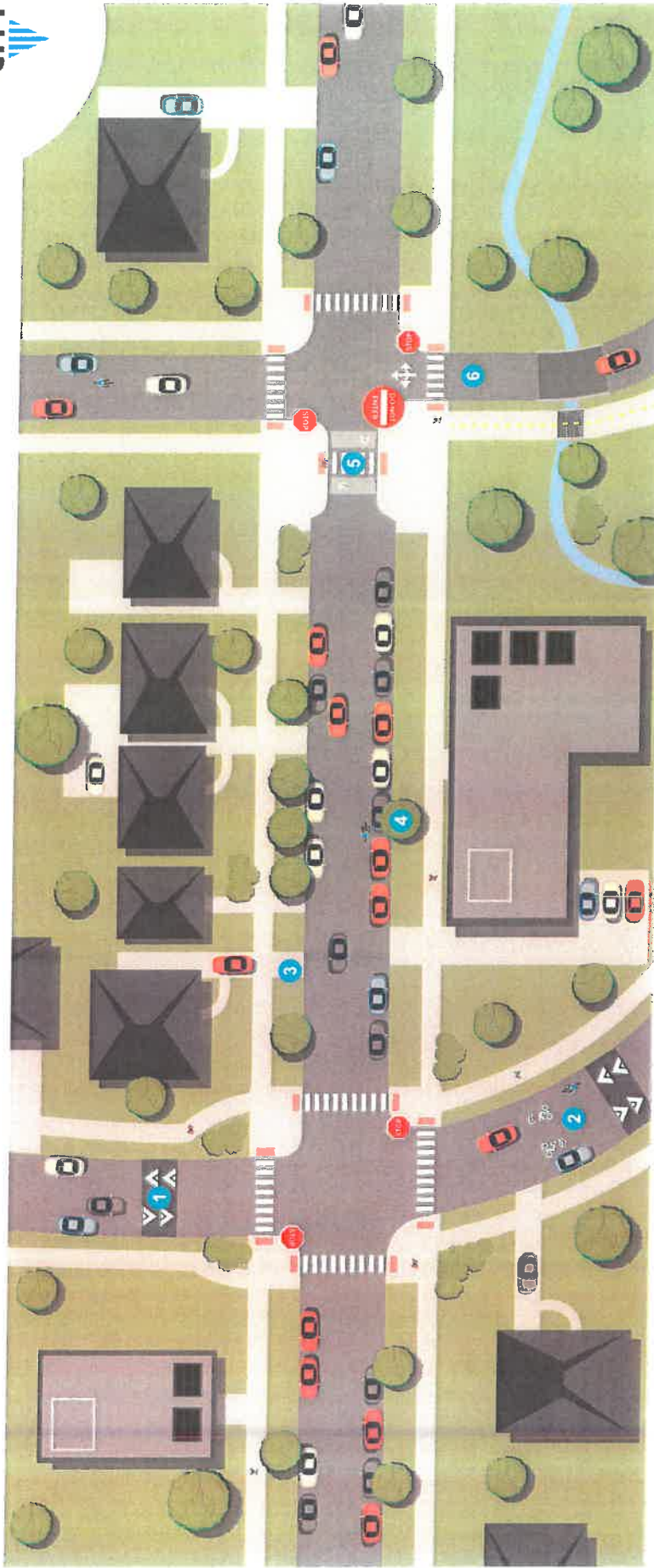

- 1 SPEED HUMPS**
Vertical deflection devices that slow vehicles, improving safety for pedestrians and cyclists.
- 2 SHARROWS**
Pavement markings on the roadway that indicate a shared lane for bicycles and vehicles, helping position cyclists safely within the lane and alerting drivers to their presence. This design element is only appropriate on streets that are low level or streets like neighborhood streets.
- 3 ON-STREET PARKING**
Parking spaces adjacent to travel lanes that provide a buffer between pedestrians and moving traffic and help to slow vehicles or visually narrow the roadway.
- 4 STREET TREES AND LANDSCAPING**
Trees, shrubs and other landscaping elements adjacent to the roadway that enhance safety and walkability by calming traffic, providing shade and improving neighborhood character.
- 5 RAISED CROSSWALK**
Crosswalks that are elevated similar to a speed hump or curb that limit turning speeds of vehicles and increase the visibility of crossing bodies of traffic.
- 6 NARROW STREETS**
Streets with reduced width available for motor vehicles have assigned to slow vehicle speeds, enhancing safety for all users and creating a more available, community-friendly environment.
- 7 TRAFFIC CIRCLE (NOT PICTURED)**
Circular intersections that slow vehicle speeds and reduce conflict points, improving safety and maintaining traffic flow at low-volume intersections.

Neighborhood Cross Section Options



50-foot ROW: Two-way segment with shared lanes



50-foot ROW: Two-way segment with shared lanes and parking permitted on both sides

Neighborhood Cross Section Options



50-foot ROW: Two-way segment with transit facilities on both sides



50-foot ROW: Two-way segment with parking permitted on both sides

Rural Neighborhood Cross Section Options



50-foot ROW: Two-way segment with paved shoulders on both sides



50-foot ROW: Two-way segment with paved shoulders on both sides

Industrial / Business Park

Industrial / Business Park streets are in areas zoned as such with heavy traffic generators. These streets serve a high volume of heavy trucks and frequent turning maneuvers.

Industrial / Business Park Example Streets

- Barry Road
- Front Street
- Manchester Trafficway
- Chouteau Trafficway
- N Kimball Drive
- N Topping Avenue
- Guinotte Avenue

Industrial / Business Park Key Characteristics

	Typical	Rural Context
Target Speed	25 mph	25–35 mph, depending on access density
Design Vehicle	WB-40	Same
Control Vehicle	Aerial Fire Truck MM100 / WB-62	Same
Right-of-Way Width	80'–100'	70'–90'
Lane Width	11'–12'	Same
Pedestrian Facilities	5'–10' sidewalk, 5'–8' buffer	Shared use path
Micromobility Facilities	Buffered or separated mobility lanes. Designers should provide the maximum possible buffer for personal mobility devices, such as bicycles.	Shared use path
Transit Facilities	Transit service is possible on Industrial / Business Park streets. Refer to "Accommodation for Transit Vehicles" under Design Guidance.	N/A
# of Travel Lanes	2 for streets < 20,000 vpd, otherwise 4	Same
Parking	No on-street parking	Same
Green Stormwater Infrastructure	Landscaping and ditch	Ditch
Curbside Uses	Landscaping	N/A
Street Activation	Low	Low
Place Type	Heavy Industrial, Light Industrial (ML, IF)	Same
Access Control	Driveways should be managed for appropriate intersection distance and sight lines. Access for major generators should be evaluated for appropriate traffic control treatments.	Same

INDUSTRIAL

This conceptual roadway diagram illustrates a range of possible segments for the given street typology and is not intended to represent a continuous roadway condition.

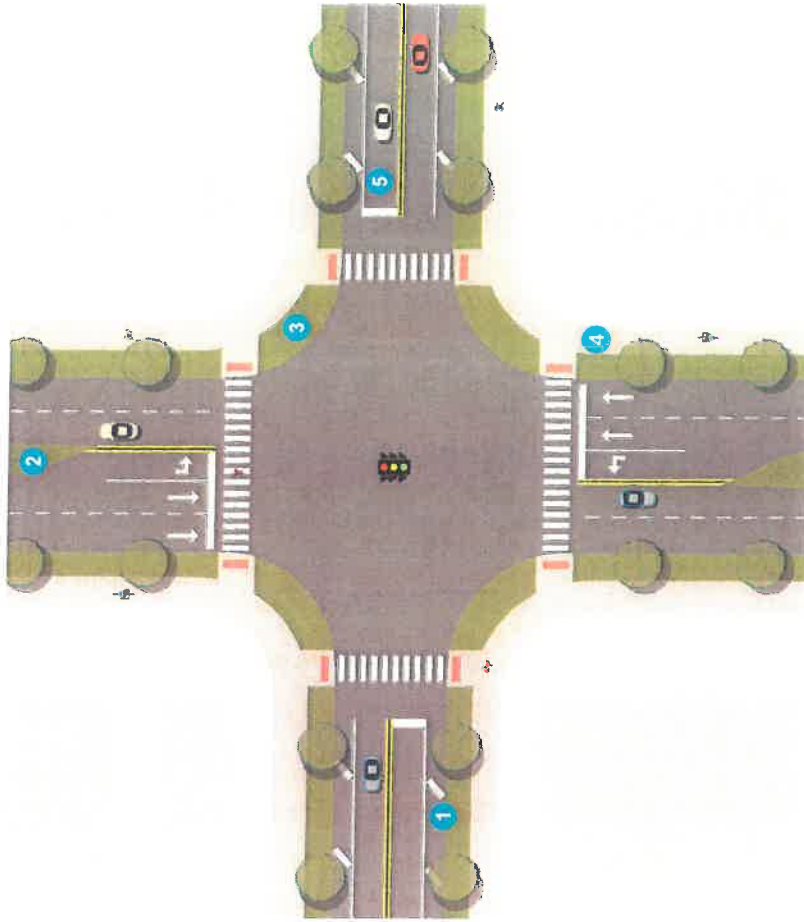

- 1 WIDE BUFFER AREA**
The shoulder and green space provide a wide buffer between heavy vehicles and pedestrians and cyclists.
- 2 DIVIDED ROADWAY**
Separate directions of travel with a median reduces the likelihood of head-on conflict between larger, heavier vehicles.
- 3 WIDER CORNER RADII**
Industrial routes use wider corner radii to accommodate the turning movements of large trucks.
- 4 SHARED USE PATH**
A 10-foot paved travel way on both sides of the street provides a shared space for all non-motorized traffic.
- 5 RECESSED STOP BARS**
Stop bars are moved back from the intersection slightly to provide more room for crossing pedestrians and to allow a wider left-turn movement.

Industrial / Business Park Cross Section Options



120-foot ROW: Two-way segment with median

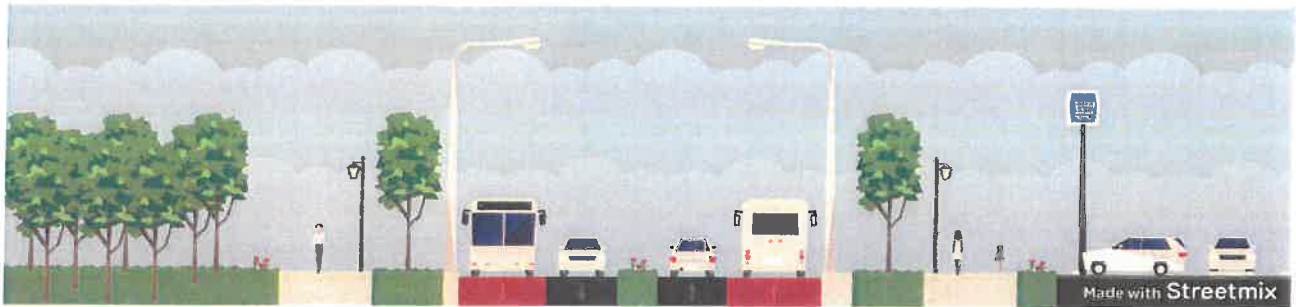

100-foot ROW: Two-way segment with median and transit-only lane on both sides



100-foot ROW: Two-way undivided segment

Boulevards and Parkways

Kansas City's historic Boulevard and Parkway system was designed to preserve green space, connect City parks, and enhance urban life. These roads are managed by the Kansas City Parks and Recreation Department, who has published standards for their design with a focus on balancing the preservation of their historic significance with the vibrance of new development.

Generally speaking, boulevards are wide, formally landscaped streets that follow the gridiron street system, accommodate multiple points of ingress/egress and have intersections at all cross streets. Historically boulevards occurred within a hundred foot right-of-way with forty foot streets and thirty foot margins (tree lawn) for wide grass verges, sidewalks and triple rows of trees equally spaced. The original description of the margin was seventeen feet of turf with a double row of trees, an eight foot sidewalk, and then five feet of turf with a single row of trees to the property line. The double row of trees between the curb and the sidewalk allowed for the street to be widened, without removing all the trees, only the row closest to the curb. To this day the boulevards are some of the city's most pleasant corridors and resemble this original design while accommodating changing vehicular traffic. When developing new boulevards, the right-of-way shall be one hundred feet in width or more without a center median. The boulevard consists of a forty-four foot roadway, fifteen foot tree lawns and eight foot sidewalks. Symmetrical plantings of one or two rows of trees in the tree lawn shall be evenly spaced on both sides of the sidewalk.

In reference to the standards document adopted by the Parks and Recreation Department: It is by way of honoring the sense of "unity through . . . pervasiveness" that guides, in many respects, the formulation of these Boulevard and Parkway Design Standards. As stewards of the original Kessler Boulevards and Parkways System, it is an obligation of the Board of Parks and Recreation Commissioners and the city as a whole, to preserve the historic integrity of that system to the extent possible. Part of the responsibility rests in the assurance that the system itself will remain distinct and that travel on and proximity to a boulevard or parkway will convey its special status.

These standards can be found at kcparks.org.

This Streets Design Guide recognizes Boulevards and Parkways as separate street typologies but acknowledges that their function overlaps with other typologies presented in this document. In some places, they function as thoroughfares, in others as connectors, and are even found in the downtown core. In the Major Street Plan, there is a layer specifying which roadways are Parkways and Boulevards. These could be classified as arterial roads or collector roads, but are still maintained and owned by the Parks and Recreation Department.

As roadway, utilities, development, and other projects take place on or near Parkways and Boulevards, there may be an opportunity to include safety improvements aligned with Vision Zero principles. Users of this Guide are encouraged to refer to the Safety Principles discussion in Section 2 and the Design Guidance in Section 4 of this document to identify potential safety-focused improvements to the design of these facilities.

Boulevards

Boulevards are wide, formally landscaped streets that follow the gridiron street system, accommodate multiple points of ingress/egress and have intersections at all cross streets. When developing new boulevards, the right-of-way shall be a minimum of 80 feet in width or more, subject to change with Park Board approval. The boulevard consists of 11-foot wide lanes, tree lawns and ten-foot sidewalks. Symmetrical plantings of one or two rows of trees in the tree lawn shall be evenly spaced on both sides of the sidewalk. Boulevards are more desired in commercial or high-density residential areas.

Boulevard Cross Section Options

- 4-lane
- 4-lane with curbed mobility lane
- 2-lane
- 2-lane with parking
- 2-lane with median and curbed mobility lane
- 2-lane with curbed mobility lane

Boulevard Example Streets

- Armour Boulevard (Parking)
- Emanuel Cleaver II Boulevard (curbed mobility lane)
- The Paseo (median)
- Admiral Boulevard (2-lane)
- Red Bridge Road (4-lane with median)
- Englewood Road (2-lane with median and trail)

Boulevards Key Characteristics

Target Speed	30 mph
Design Vehicle	DL-23
Control Vehicle	Standard Pump Fire Truck
Lane Width	11' minimum
Pedestrian Space	For new construction or reconstruction projects, the sidewalk must be a minimum of 10' on both sides of the street meeting the Boulevard and Parkway Standards for sidewalks located in commercial areas.
Buffer Space	5'–15' of green space between road and sidewalk or path
Micromobility Facilities	Curbed mobility lanes, off-street trail separate from sidewalk. Acceptable materials for separated mobility lanes include poured concrete curbing/median. The preferred mobility facility would be raised to sidewalk level and fully separate from vehicle lanes and sidewalk. If a shared use path is selected, a minimum width of 12' shall be used.
Transit Facilities	Space should be provided for shelters and/or mobility hubs along continuous corridors that are current KCATA routes or may become one in the future. Approval from the Parks and Recreation Board of Commissioners is required for any installation of shelters or mobility hubs. Transit stops should focus on far side stops unless a key generator is located on the near side.
Freight	Design should not accommodate these vehicles as they are prohibited on parkways and boulevards.
Parking	Residential – Allowed on both sides – 8' in width Non-Residential – Per approved plans – 8' in width
# of Travel Lanes	2 or 4
Green Stormwater Infrastructure	Native plantings and street trees as approved by the Parks and Recreation Department Development Review Committee and the Parks and Recreation Board of Commissioners.
Curbside Uses	Transit stops, on-street parking, shared mobility stations, bicycle parking
Street Activation	Medium/High
Place Type	All

*see Parkway and Boulevard Standards for more detail at kcparks.org

BOULEVARDS

This conceptual roadway diagram illustrates a range of possible segments for the given street typology and is not intended to represent a continuous roadway condition.

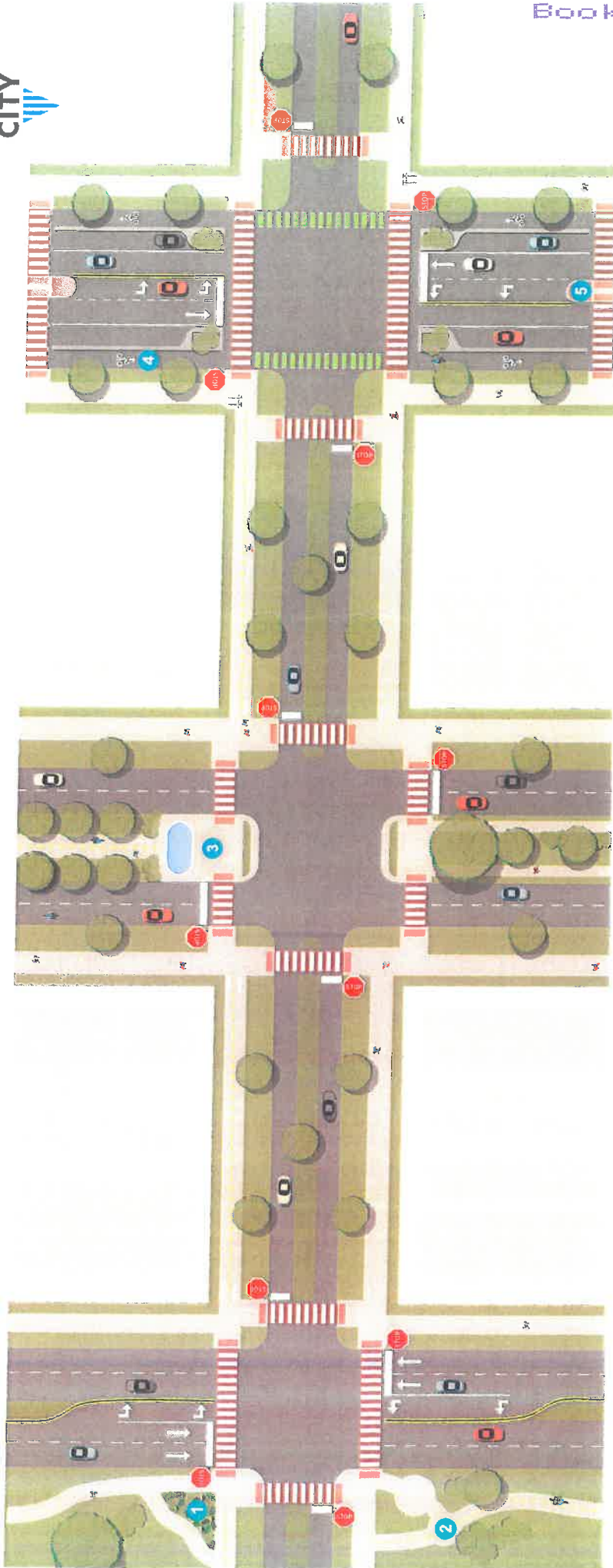

- 1 RAIN GARDEN**
 A landscaped area that collects and filters stormwater runoff, helping reduce flooding and improve water quality.
- 2 SHARED USE PATH**
 A wide path designed for pedestrians, cyclists, and other non-motorized travelers that promotes safe, active transportation away from traffic.
- 3 ACTIVATED MEDIANS**
 Enhanced median space with landscaping or amenities that calm traffic and create more engaging pedestrian-friendly streets.
- 4 SEPARATED BICYCLE FACILITIES**
 Bike lanes that are physically divided from vehicle traffic, offering a safer and more comfortable experience for cyclists.
- 5 PEDESTRIAN REFUGE ISLAND**
 A median with a refuge area that provides pedestrians a protected area to cross a multi-lane road. Two stages if necessary.

Boulevard Cross Section Options

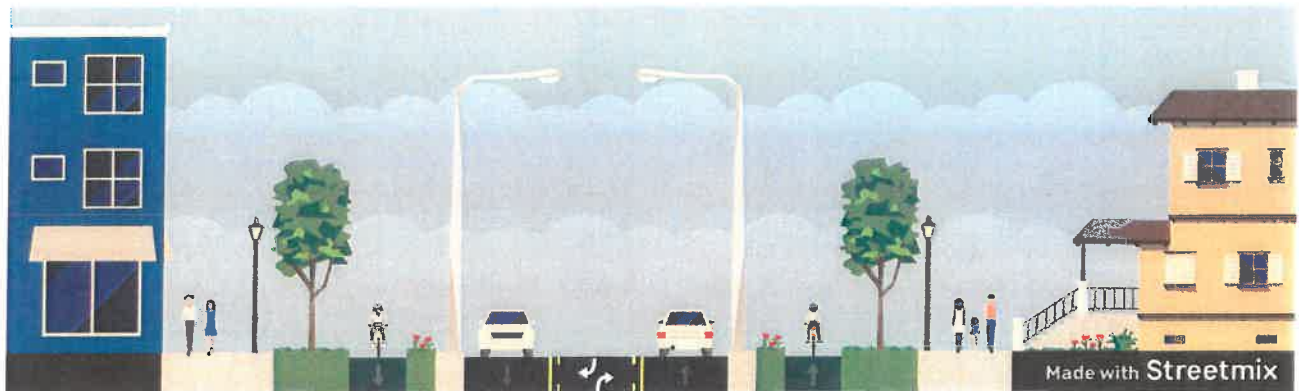

100-foot ROW: Two-way segment with center turn lane and separated mobility lane on both sides

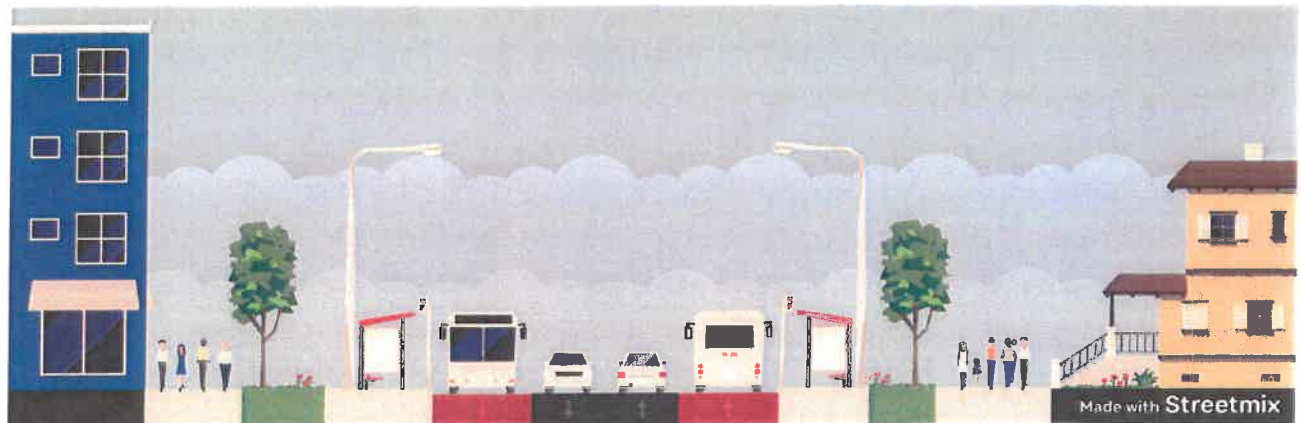

120-foot ROW: Two-way segment with transit-only lane on both sides

Parkways

Parkways are less formal in alignment, following the natural terrain and retaining a pastoral quality even as they wind through developed areas. Parkways generally run north and south with wide medians and side panels. The right-of-way is a minimum of 150 feet, with a large median.

Parkway Cross Section Options

- 4-lane
- 2-lane
- 2-lane with personal mobility lane
- 4-lane with personal mobility lane

Parkway Example Streets

- NW Briarcliff Parkway (traffic circle with medians)
- Gillham Road (separated mobility lanes)
- Ward Parkway (activated median)
- Maple Woods Parkway (trail and sidewalks on both sides)

Parkways Key Characteristics

Target Speed	35 mph
Design Vehicle	DL-23
Control Vehicle	Standard Pump Fire Truck
Lane Width	11' minimum
Pedestrian Space	For new construction or reconstruction projects, the sidewalk must be a minimum of 10' on both sides of the street meeting the Boulevard and Parkway Standards for sidewalks located in commercial areas.
Buffer Space	Minimum 10' minimum
Micromobility Facilities	Curbed mobility lanes, off-street trail separate from sidewalk. Mobility (bicycle) amenities to be approved by the Parks Board.
Transit Facilities	Space should be provided for shelters and/or mobility hubs along continuous corridors that are current KCATA routes or may become one in the future. Approval from the Parks and Recreation Board of Commissioners is required for any installation of shelters or mobility hubs. Transit stops should focus on far side stops unless a key generator is located on the near side.
Freight	Design should not accommodate these vehicles as they are prohibited on parkways and boulevards.
Parking	On-street parallel parking may be allowed with approval from the Parks and Recreation Board of Commissioners.
# of Travel Lanes	2-4
Green Stormwater Infrastructure	Native plantings and street trees, as approved by the Parks and Recreation Department Development Review Committee and the Parks and Recreation Board of Commissioners. Trees may be clustered when used within a green stormwater infrastructure practice.
Curbside Uses	Transit stops, shared mobility stations, bicycle parking
Street Activation	Medium/High
Place Type	All

*see Parkway and Boulevard Standards for more detail at kcparks.org

PARKWAYS

This conceptual roadway diagram illustrates a range of possible segments for the given street typology and is not intended to represent a continuous roadway condition.



- 1 HIGH VISIBILITY CROSSWALK**
A crosswalk that provides increased visibility to motorists through high-visibility pavement markings, signage, and lighting.
- 2 TWO-WAY CYCLE TRACK**
Separated bike lanes that allow bicycle movements in both directions on one side of the street.
- 3 ROUNDABOUT**
Circular intersection that reduces vehicle speed, improves traffic flow, and lowers the risk of serious right-angle collisions compared to traditional intersections.
- 4 SHARED USE PATH**
A wide path designed for pedestrians, cyclists, and other non-motorized travelers that promotes safe return transportation away from traffic.
- 5 PEDESTRIAN REFUGE ISLAND**
A median with a refuge area that provides pedestrians a protected area to cross a multi-lane road when a signal is necessary.
- 6 SEPARATED MOBILITY LANE**
A mobility lane at sidewalk level, separated from the sidewalk and roadway.

Parkway Cross Section Options



150-foot ROW: Two-way segment with wide median and two-way mobility lanes in the median



200-foot ROW: Two-way segment with wide median and park area between travel lanes and sidewalk

Trails

Trails provide systems for non-motorized transportation and recreational opportunities for bicyclists, joggers and walkers. Trails shall be designed to meet the recommendations in the AASHTO Guide to the Development of Bicycle Facilities and the Trails KC Plan.

The trail shall be designed in a way that provides adequate access, is direct and convenient, shall blend with natural environment, and takes in consideration the topography of the land. The location of trails can vary from abandoned railroad corridors, rail-with-trails corridors, waterways, including levees, parks, greenways, stream corridors, stream buffers zones, utility corridors, parkways, street and highway corridors. All development within ¼ mile of a citywide trail alignment either constructed or planned shall be required to provide a connection to citywide trail. There are different trails to recognize:

Neighborhood Connector trails are public, non-motorized shared-use “local trail” that connects neighborhoods to the regional trails.

- Recommended width 8 feet. Any trails proposed that do not meet the standard width must be approved by Parks and Recreation Department Development Review Committee
- Smaller, shorter distance trails with neighborhood connectors, minimum 8 feet wide
- Examples:
 - Copperleaf subdivision (N Flintlock Road & NE 90th Street)

Regional trail is a public, non-motorized shared-use trail facility that serves as a primary or regional trail.

- Recommended minimum width 10 feet minimum with a maximum width of 12 feet
- Provides major connections throughout the city and to neighborhood communities
- Trail is longer trail with significant trail connectors
- Examples:
 - Line Creek Trail
 - Shoal Creek Trail
 - Blue River Trail
 - Trolley Track Trail

Trails adjacent to roadways are covered within the other street typologies. This section refers to trails that are not adjacent to roadways.

Minimum widths here mean that no utility poles, furnishings, equipment are within the trail width. Those items would be within a furnishing zone or buffer zone area.

On Boulevard	Trails not allowed
On Parkway	Encouraged as part of recreation facilities
Width of trail (parkway or regional trail)	10' minimum and 12' maximum
Width of trail (other trails)	8' minimum if space is not allowed for standard width. Required to get approval from Parks and Recreation Department Development Review Committee for other width desired
Width of trail (Gillham Road between Linwood Boulevard and Emanuel Cleaver II Boulevard)	8' wide located within the median (Hyde Park)

Design Guidance

Introduction

This section outlines the guidance to follow when designing City facilities in accordance with the City's [Complete Streets Policy \(Ordinance 170949, Chapter 64-41\)](#), [Vision Zero Action Plan \(kcmo.gov/visionzero\)](http://kcmo.gov/visionzero), [Standard Drawings](#), and national industry standards. This guidance is intended to reflect and implement safety for all modes of travel with an emphasis on pedestrian, bicycle, and transit accommodations.

This section informs the planning and design of all future street projects in Kansas City, including street reconstructions and street retrofit projects. The Street Design Guide also informs how the City will approach street projects led by partner agencies such as the Missouri Department of Transportation, the Mid-America Regional Council, local counties, or Kansas City Area Transportation Authority.

When managing a project on an individual street, designers are encouraged to use the interactive [Streets Design Guide Map \[include hyperlink when available\]](#) to find basic information about the street, including its street typology and place in the modal network. They can then use this guidance to supplement design information provided under "Typologies". Design criteria for specific projects will be established with a City project manager or representative. The "Implementation" section explains:

1. How and when to use the Streets Design Guide
2. When to vary from the Streets Design Guide
3. Key resources and partners for street design

Many design features can be implemented as "quick-build" projects (also known as tactical, temporary, or demonstration), which offer:

- Quick, low-cost installation (with a design lifetime of 1–5 years)
- An opportunity for the public to interact with and respond to improvements
- A chance to evaluate improvements before committing to long-term capital projects

The implementation of quick build projects may be initiated by public request, in response to safety issues, in coordination with redevelopment activities, or as part of the public involvement process for complex future street redesigns.

Pedestrian Facilities

Sidewalks and Shared Use Paths

Sidewalk

Sidewalk is defined under Elements of Design. Design of sidewalks is regulated by the ADA with full details in the ADA PROWAG. Recommended sidewalk and buffer widths are specified in Typologies and may be wider than the general guidance provided below. Consideration may be given to not include sidewalks in areas where origins and destinations are not within feasible walking distance. In these cases, City project manager must agree to omit sidewalks. In these cases, it is intended to review the project's Pedestrian Level of Stress based on the City's Sidewalk Prioritization Plan to understand the importance of updates to these features to the area. For exceptions to be made, the City project manager must agree to omit sidewalks.

The minimum width of public sidewalks is stated within each street typology. The minimum width of public sidewalks abutting curb shall be six feet. All public sidewalks shall be a minimum of four inches thick. A sidewalk which is used for mixed traffic shall be six inches thick.

Sidewalks	
Min width utilizing buffer*	5'
Min width for pedestrian refuge	6'
Min width at back of curb	6'
Min running slope	1%
Max running slope (not a ramp)*	5%
Max cross slope	2%
ADA ramp max slope**	8.30%
Min turning space dimensions	4' x 4'

*for new construction, sidewalk should be 10' on both sides of the roadway (see Neighborhood typology for exception)

**exceptions for sidewalk parallel to a roadway to run at the road grade that exceeds this value where appropriate

***slope may exceed this value if ramp is >15' long

Shared Use Path

Shared use path is sidewalk 10 feet or greater in width. It is intended for use by pedestrians and micromobility devices. Paths must be wide enough to accommodate pedestrians and bicyclists traveling at variable speeds in both directions.

Shared Use Paths	
Min width	10'
Max cross slope	2%
Design Speed*	Refer to AASHTO Bike Guide design speeds
Clear zone width	3'
Unpaved shoulder width**	4'

**used if path is not parallel to roadway within street R/W*

***2' can be used for trail/path width $\geq 12'$*

Lighting

To illuminate the front of pedestrians and avoid silhouetting, lighting should be placed 10 feet in advance of intersection and midblock crossings on both approaches rather than directly above the crossing or behind it.

Specialty pedestrian lighting along sidewalks may be appropriate in commercial, urban and urban mixed use areas to enhance pedestrian comfort, security and safety, especially where street lighting and building lights do not adequately illuminate pedestrian areas. Consideration must be given to long-term costs and maintenance of these lights.

Amenities

Any street amenities placed within the pedestrian space shall not impact the clear width of the sidewalk or provide any hazards for pedestrians.

Cafes and Parklets

Sidewalk cafes and parklets should not inhibit ADA compliance—5 feet of clear sidewalk width is required. Cafes should place a retro-reflective strip placed adjacent to traffic and include a 1-foot buffer around the perimeter. They are not appropriate on streets with speeds greater than 30 mph.

Parklets

Parklet	
Min Length for parallel parking	One Space (18'–20')
Min Length for angled parking	Three Spaces (27')
Min buffer between Parklet and adjacent parking	4'
Min. width	6'
Min. buffer between Parklet and traveled way	2'

Sidewalk Cafes

Category	Element	Specification
Location & Siting	Minimum Lane Clearance	12' required unobstructed width of a travel lane next to a street café
	Corner Setback	20' from crosswalks
	Drainage Flow	6" minimum clearance from gutter/inlet flow lines
	Deck Gap	¼" spacing between planks for rainwater runoff
Platform/Deck	Surface Slope	≤ 2% cross slope; flush with adjacent sidewalk for ADA
	Load Capacity	≥ 100 psf live load (per IBC standards)
	Materials	Non-slip decking (wood, composite, steel, etc.)
	Fastening	Mechanically secured, no exposed bolts into pavement
	Access Ramps	Required if platform is > ½" above sidewalk height
Traffic Separation	Edge Protection	Barriers, planters, bollards at both ends of café zone
	Barrier Height	≥ 30" to provide deflection from vehicles
	Bollard Spacing	4' on-center, minimum 36" ADA gap
	Crashworthiness	Use ASTM F3016-rated or equivalent for high-volume roads
Visibility & Delineation	Reflective Strips	3" wide retroreflective tape on all barrier edges
	Signage	New Signage (to be adopted by City Council): "Café Zone Ahead", lane shift warnings
	Lighting	Overhead Café lights or string lights
Pavement Markings	Boundary Lines	White/yellow thermoplastic lines outlining café perimeter
Furniture & Fixtures	Table/Chair Clearance	Minimum 36" for ADA-compliant pathways
	Anchoring	Furniture must be anchored or weighted for wind > 30 mph
	Umbrella/Awning Height	≥ 7' clearance; must not obstruct driver or pedestrian sightlines
Drainage	Deck Gap	¼" – ½" spacing between planks for rainwater runoff
Fire Hydrants & Utility Access	Access	At least 5' clearance on either side of the fire hydrant Maintain 3' clearance on either side of utility boxes, manholes

Roadway Artwork

“Roadway Artwork” is murals or art is painted onto the asphalt or concrete pavement. Artwork outside of the driving lanes and outside of crosswalks is allowed with approval from the Director of Public Works. Artwork within the driving area of the roadway is not permitted.

Intersection murals should not be used as a traffic calming measure, though they may have that result. They are most appropriate along low-volume streets in conjunction with other traffic calming methods with speeds below 20 mph. Murals are typically installed with acrylic traffic paint and should not encroach into crosswalk striping. Street surfaces should be thoroughly swept and power washed before artwork is applied.

Micromobility Facilities

Preferred materials for separated mobility lanes include poured concrete curbing/median. Delineators or other temporary materials are acceptable as an alternative. The City shall approve of any materials used for personal mobility facilities.

Applicability of Personal Mobility Facilities		
Personal Mobility Facility Type	Vehicle Speed (mph)	Volume (vpd)
Separated mobility lane	Any	Any
Buffered mobility lane	≤ 25	≤ 6,000
Traditional mobility lane	≤ 20	≤ 3,000
Bicycle boulevard	≤ 15	≤ 2,000

Separated Mobility Lanes (Major Separation)

Separated mobility lanes utilize a physical barrier from vehicular traffic.

Protected Mobility Lanes

Buffered Mobility Lanes	
Preferred width	5'
Min width	4'
Min horizontal separation from vehicular traffic	3'
Delineator spacing	8'–20'

*Horizontal separation from vehicular traffic can be reduced in constrained conditions