



# CITY PLAN COMMISSION STAFF REPORT

City of Kansas City, Missouri  
City Planning & Development Department  
[www.kcmo.gov/cpc](http://www.kcmo.gov/cpc)

December 6, 2022

**Project Name**  
Summit View Farms

**Docket #6**

**Request**

**6.1: CD-CPC-2022-00177**

- Rezoning without plan

**6.2: CD-CPC-2022-00178**

- Development Plan (Preliminary Plat)

**Applicant**

Rachelle Biondo  
Rouse Frets White Goss Gentile Rhodes  
4510 Belleview  
Kansas City, MO 64111

**Owner**

Summit View Farms Development Group, LLC.

Location 13399 E. 139<sup>th</sup> Street  
Area About 145 acres  
Zoning R-80  
Council District 6<sup>th</sup>  
County Jackson  
School District Lee's Summit

**Surrounding Land Uses**

**North:** Single Family residences, zoned R-10

**South:** Summit Pointe Elementary School, zoned R-80

**East:** Single Family residences, zoned residential within the City of Lee's Summit.

**West:** Single Family residences on large tracts and agricultural farmlands.

**Major Street Plan**

**East 139<sup>th</sup> Street** identified on the City's Major Street Plan as a thoroughfare with 2 lanes at this location. **Horridge Road** is not identified at this location.

**Land Use Plan**

The Longview Area Plan recommends Residential Low Density and Open Space/ Buffer land use for this location.

**APPROVAL PROCESS**



**PROJECT TIMELINE**

The application for the subject request was filed on October 6, 2022. No scheduling deviations from 2022 Cycle W have occurred.

**NEIGHBORHOOD AND CIVIC ORGANIZATIONS NOTIFIED**

There are no registered neighborhood or homes associations tied to the subject site.

**REQUIRED PUBLIC ENGAGEMENT**

Public engagement as required by 88-505-12 applies to this request. Applicant hosted a meeting on November 3, 2022. A summary of the meeting is attached to the staff report, see Attachment #3.

**EXISTING CONDITIONS**

The project site is a 145-acre parcel generally located at the southeast corner of E. 139<sup>th</sup> Street and Horridge Road. This parcel is part of an existing residential development (Summit View Farms) currently under development in the City of Lee's Summit, Missouri. To the north of the subject site are existing single-family residences within Monarch View subdivision. Summit Pointe Elementary School (Lee's Summit School District) is directly south of the development. To the east are single family residences within the City of Lee's Summit. Summit View Farms 1<sup>st</sup> through 5<sup>th</sup> Plats are partially developed and occupied, and this parcel will be an extension of that subdivision westward into the City of Kansas City. To the west are single family residences on large tracts and agricultural lands.

**SUMMARY OF REQUEST + KEY POINTS**

The applicant is seeking approval of a rezoning from District R-80 to District R-7.5 and approval of a Development Plan which also serves as a preliminary plat to allow for the creation of 300 detached residential lots and 9 tracts in 7 phases.

**CONTROLLING**

There is no controlling case for the site.

**PROFESSIONAL STAFF RECOMMENDATION**

Docket #6.1 CD-CPC-2022-00105- **Approval**

6.2 CD-CPC-2022-00106- **Approval with Conditions**

**RELATED CASES**

**CD-CPC-2019-00227** – Ordinance No. 200928 passed by the City Council on December 3, 2020, approved a preliminary plat in District R-80 to allow for two common area tracts of land for the Summit View Farms 5th Plat on about 6.27 acres generally located at northwest of the intersection of SW Summit View Trail and SW National Avenue.

**CLD-FnPlat-2019-00041** – On January 21, 2021, the City Plan Commission approved a final plat in District R-80 to allow for two common area tracts of land for the Summit View Farms 5th Plat on about 6.27 acres generally located at northwest of the intersection of SW Summit View Trail and SW National Avenue. City Council action pending.

**PROJECT LOCATION**

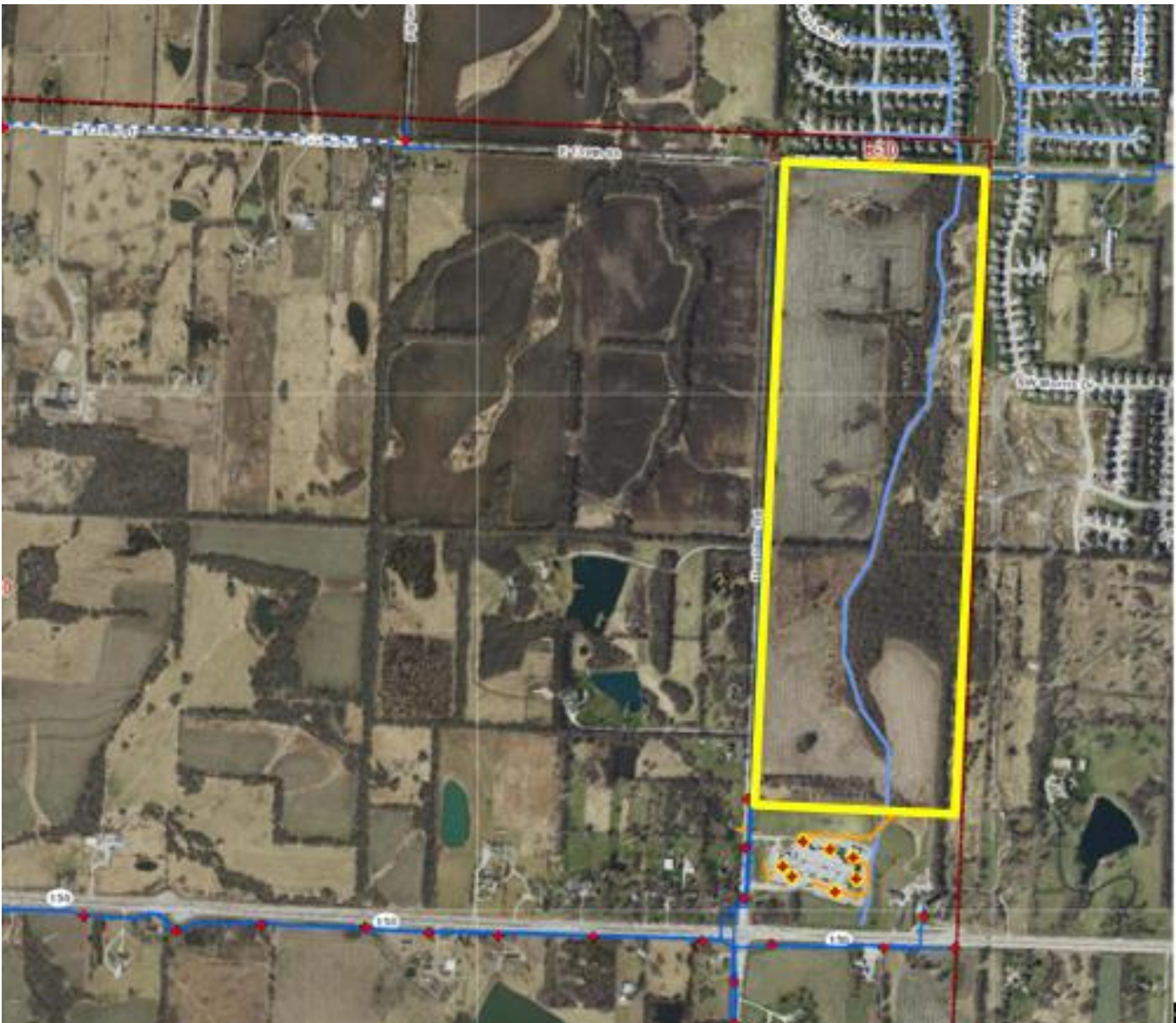

## PLAN REVIEW

These companion cases are necessary as the applicant is seeking approval of a rezoning from District R-80 to District R-7.5 and approval of a Development Plan which also serves as a preliminary plat to allow for the creation of 300 detached residential lots and 9 tracts. The subject site is generally located at the southeast corner of E. 139th Street and Horridge Road.

**Case No. CD-CPC-2022-00177** is a request to consider rezoning the 145-acres tract of land from District R-80 to District R-7.5.

### AREA PLAN:

The site is within the Longview Area Plan which recommends Low Density Residential land use for the subject property. The proposed development plan is in conformance with the Area Plan future land use recommendation therefore an area plan amendment is not necessary.

**Case No. CD-CPC-2022-00178** is a request to consider approval of a development plan which also serves as a preliminary plat, in District R-7.5 on about 145 acres to allow for 300 detached lots and 9 tracts in 7 phases. The plan is part of the "Summit View Farms" residential subdivision. Summit View Farms is a residential subdivision 190-acre residential development within the Cities of Lee's Summit and Kansas City Missouri. About 145 acres will be in KCMO and about 47 acres in the City of Lee's Summit (See Attachment #4).

The development plan with KCMO proposes 300 lots with public street extending eastwards to connect to the existing subdivision in Lee's Summit. The project proposes 248 detached residential lots and 52 maintenance provided single family lots. The detached homes will have an average of 70 foot lot width and 8,500 square foot lot area, while the maintenance provided lots will have an average of 60 foot lot width and 7,200 square foot lot area. Setbacks are proposed to be 30 feet front and rear and 15 feet side on corner. The site does preserve about 20 acres within the stream buffer area and proposes trails and other amenities in lieu of parkland dedication. There is an accompanying stream buffer preliminary plan.

The subdivision shows a total of 7 street connections to existing street and one future street. There is also a trail connection to Summit Pointe Elementary School to the south. The plan also proposes sidewalk on one side of the local public streets to be similar to the existing phases within Lee's Summit. East 139th Street is on the Major Street Plan (MSP) so the developer is not required to construct the half street improvements but pays an impact fee. Horridge Road is not on the MSP. The proposed plan shows the required 30-foot landscaped buffers which will screen the rear portions of the properties from the public Right of Way on E. 139th Street and Horridge Road.

## PLAN ANALYSIS

Residential, Commercial, or Industrial Lot and Building (88-110), Use- Specific (88-300), and Development Standards (88-400)

*\*indicates adjustment/deviation*

Standards	Applies	Meets	More Information
Lot and Building Standards (88-110)	YES	YES	
Boulevard and Parkway Standards (88-323)	NO	N/A	
Parkland Dedication (88-408)	YES	YES	See analysis below.
Parking and Loading Standards (88-420)	YES	YES	Off street parking is proposed.
*Landscape and Screening Standards (88-425)	YES	NO	See analysis below.
Outdoor Lighting Standards (88-430)	NO	N/A	
Sign Standards (88-445)	YES	YES	Must comply with 88-445.
*Pedestrian Standards (88-450)	YES	NO	Need sidewalks on both sides of local internal streets. See analysis below.

## Requested Waivers

**Double Sided Lots - Section 88-405-05 (E&F)** – Lots with double frontage requiring 30 foot landscape buffer. Staff is supportive of a modification to the required 30 foot buffer along Horridge Road per City Planning and Water Service Department approval to accommodate the 30" water transmission main prior to ordinance request. This should include additional buffer and restriction language for Lots 294-299 and Lot 286.

**Sidewalks - Section 88-405-07** - Sidewalks must be provided in accordance with the department of public works' Standards, Specifications, and Design Criteria. Decision making bodies are authorized to allow trails to be substituted for sidewalks.

The applicant is requesting a waiver to this requirement to only install sidewalks on one side of the local public streets. Staff is not supportive of this request as it does not meet the public work's standard and will leave the burden of installing the remaining sidewalks on the city down the road. The applicant also has not provided staff with any rationale as required by Section 88-405-25-C-1 below:

**88-405-25-C - To recommend or approve a waiver or modification of subdivision design and improvement standards, the city plan commission and city council must determine that all of the following conditions exist:**

**88-405-25-C-1.** *That there are special circumstances or conditions affecting the property;*

**88-405-25-C-2.** *That the waiver or modification is necessary for reasonable and acceptable development of the property in question and is not a greater modification or waiver than is required to allow reasonable and acceptable development of the subject property; and*

**88-405-25-C-3.** *That the granting of the waiver or modification will not be detrimental to the public welfare or injurious to other property in the vicinity in which the subject property is situated.*

### Parkland Dedication:

According to Chapter 88-408 of the Zoning and Development Code, the developer can either, dedicate land for public park, provide open space for park purposes or provide money in lieu of parkland dedication. A plat is providing a need for the following:

300 single-family lots x 3.7 x 0.006 = 6.6 acres

0.36 acres x \$64,220.18 (2022 Fees) = \$427,706.34

### SPECIFIC REVIEW CRITERIA

#### Zoning and Development Code Map Amendments, Rezonings (88-515-08)

In reviewing and making decisions on proposed zoning map amendments, the City Planning and Development Director, City Plan Commission, and City Council must consider at least the following factors:

**A. Conformance with adopted plans and planning policies;**

The Longview Area Plan recommends Residential Low Density and Open Space/ Buffer land use for this location. The proposed use is consistent. OA

**B. Zoning and use of nearby property;**

Nearby properties are primarily single-family homes on large tract of land and within subdivisions. This proposal will be compatible. OA

**C. Physical character of the area in which the subject property is located;**

The proposed plan will be compatible with the physical character of the area. OA

**D. Whether public facilities (infrastructure) and services will be adequate to serve development allowed by the requested zoning map amendment;**

Utilities and infrastructure will be brought to City Standards, subject to the conditions in the attached report. OA

**E. Suitability of the subject property for the use to which it has been restricted under the existing zoning regulations;**

The current zoning designation is R-80 and the development cannot be done under the existing zoning. OA

**F. Length of time the subject property has remained vacant as zoned;**

The subject property has never been developed. OA

**G. The extent to which approving the rezoning will detrimentally affect nearby properties; and**

The rezoning is not expected to detrimentally affect nearby properties. OA

**H. The gain, if any, to the public health, safety, and welfare due to denial of the application, as compared to the hardship imposed upon the landowner, if any, as a result of denial of the application.**

A denial of the application would not allow the development to occur thereby limiting the ability of the developer to complete this project. OA

**Development Plans, Project Plan, or Site Plan (88-516-05)**

In order to be approved, a development plan, project plan, or site plan must comply with all of the following criteria:

**A. The plan must comply with all standards of the Zoning and Development Code and all other applicable city ordinances and policies;**

The development plan complies with the applicable sections of the Zoning and Development Code and the recommended land use of the Longview Area Plan. OA

**B. The proposed use must be allowed in the district in which it is located;**

Detached houses are permitted in the R-7.5 zoning district. OA

**C. Vehicular ingress and egress to and from the site, and circulation within the site must provide for safe, efficient, and convenient movement of traffic not only within the site but on adjacent roadways;**

The proposed plan meets the requirements for vehicular access and circulation. OA

**D. The plan must provide for safe, efficient, and convenient non-motorized travel opportunities, being pedestrian and bicycle movement, on the subject site;**

The proposed development is asking for a waiver to only provide sidewalks on one side of the local public streets which does not meet the public works standards. Staff is not supportive of this request. See analysis. OA

**E. The plan must provide for adequate utilities based on City standards for the particular development proposed.**

There are adequate utilities proposed for the site. Existing sewer and water main connections are available. OA

**F. The location, orientation, and architectural features, including design and material, of buildings and other structures on the site must be designed to be compatible with adjacent properties.**

The Development Plan is proposing single family homes which is compatible with the surrounding land uses. OA

**G. Landscaping, berms, fences, and/or walls must be provided to buffer the site from undesirable views, noises, lighting, or other off-site negative influences and to buffer adjacent properties from negative influences that may be created by the plan.**

The development plan did not include a preliminary landscape plan to allow staff to review compliance with 88-405-05-F and 88-425-04-B of the Zoning and Development Code. Staff recommends submittal of a preliminary landscape plan per staff approval prior to ordinance request and a Project Plan for each Private Open Space Tract for to City Plan Commission approval. OA

**H. The design of streets, drives, and parking areas within the project should result in a minimum of area devoted to asphalt or other impervious surfaces consistent with the needs of the project and city code requirements.**

The proposed site plan provides an efficient layout for the proposed uses and does not create unnecessary impervious surfaces. OA

**I. The plan must identify trees to be removed and trees to be preserved during the development of the subject property with the goal of saving trees that are not required to be removed for the development of the property.**

There is little to no existing vegetation on site as it is used primarily for agriculture currently. The existing trees within the regulated stream area are shown on the preliminary stream buffer plan and will be preserved. OA

#### ATTACHMENTS

1. Conditions Report
2. Applicants Submittal
3. Public Engagement Materials
4. Summit View Development Pamphlet

#### PROFESSIONAL STAFF RECOMMENDATION

City staff recommends the following as stated in the conditions report:

- 6.1- CD-CPC-2022-00105- **Approval**
- 6.2- CD-CPC-2022-00104- **Approval with Conditions**

Respectfully Submitted,



Olofu Agbaji  
Planner



## Plan Conditions

Report Date: December 02, 2022

Case Number: CD-CPC-2022-00178

Project: Summit View Farms

---

*Condition(s) by City Planning and Development Department. Contact Olofu Agbaji at (816) 513-8815 / [Olofu.Agbaji@kcmo.org](mailto:Olofu.Agbaji@kcmo.org) with questions.*

1. That the developer submit a Street Naming Plan to Development Management Division prior to issuance of Building Permit for any phase/ lot. Street naming plan shall be approved prior to Mylar approval of the first final plat.
2. The developer shall submit an affidavit, completed by a landscape architect licensed in the State of Missouri, verifying that all landscaping required of the approved plan has been installed in accordance with the plan and is healthy prior to Certificate of Occupancy.
3. That the developer submit a project plan to the City Plan Commission for all private open space indicating plans for landscaping, grading, detailed internal circulation, signage, lighting and a photometric study showing zero foot candles at the property lines prior to Mylar approval or issuance of building permit.
4. That the developer submit revised plat drawings and documents for CLD-FnPlat-2019-00041, Summit View 5th Plat to allow for submittal to City Council prior to ordinance request of this plan.
5. a. Sidewalks on both sides of all local public streets within the development.  
b. A preliminary landscape buffer plan sheet depicting the treatment of the 30 foot POS along Horridge Road as it relates to the existing water main transmission line and for Lots 294-299 and Lot 286. This should include a cross section to ensure that the rear yards are adequately buffered from the public rights of way.  
c. Label each noncontiguous tract as a separate tract on the face of the plat. Try to number them to correspond with each phase to remain consistent.  
d. Call out any request for waiver, deviation and modification to the subdivision regulations. This cannot be placed in the notes. Add proposed modifications to the 30 foot POS buffer to this section also.

*Condition(s) by City Planning and Development Department. Contact Terry Thomas at / [Terry.A.Thomas@kcmo.org](mailto:Terry.A.Thomas@kcmo.org) with questions.*

6. The developer must pay impact fees as required by Chapter 39 of the City's Code of ordinances as required by the Land Development Division.
7. The developer shall submit construction plans in compliance with adopted standards for all improvements required by the traffic study approved by the Public Works Department, and shall secure permits for those improvements as required by the Land Development Division, prior to recording the plat.
8. The developer shall submit verification of vertical and horizontal sight distance for the drive connection to public right-of-way to the Land Development Division and make improvements to ensure local jurisdiction and/or minimum AASHTO adequate sight distance standards are met, prior to issuance of any certificate of occupancy.
9. The owner/developer must submit plans for grading, siltation, and erosion control to Land Development Division for review and acceptance, and secure a Site Disturbance permit for any proposed disturbance area equal to one acre or more prior to beginning any construction activities.
10. The developer must secure permits to extend public sanitary and storm water conveyance systems to serve all proposed lots within the development and determine adequacy of receiving systems as required by the Land Development Division, prior to recording the plat or issuance of a building permit whichever occurs first.
11. The developer must submit a Macro storm drainage study with the first Plat or Phase, from a Missouri-licensed civil engineer to the Land Development Division showing compliance with current adopted standards in effect at the time of submission, including Water Quality BMP's, to the Land Development Division for review and acceptance for the entire development area, and submit Micro storm drainage study with each subsequent Plat or Phase showing compliance with the approved Macro and adopted standards. The developer shall secure permits to construct any improvements as necessary to mitigate impacts from rate, volume, and quality of runoff from each proposed phase, prior to recording the plat or prior to issuance of a Building Permit, whichever occurs first as required by the Land Development Division.

*Condition(s) by City Planning and Development Department. Contact Terry Thomas at / Terry.A.Thomas@kcmo.org with questions.*

12. The developer must dedicate additional right of way [and provide easements] for E 139th Street as required by the adopted [Major Street Plan and/or Chapter 88] so as to provide a minimum of 50 feet of right of way as measured from the centerline, along those areas being platted, or seek approval recommendations from the Transportation and Development Committee for any variances requested to the Major Street Plan prior to City Plan Commission approval.
13. The developer shall cause the area to be platted and processed in accordance with Chapter 88, Code of Ordinances of the City of Kansas City, Missouri, as amended, commonly known as the Development Regulations.
14. The developer must provide an erosion hazard analysis for areas where any improvements or public right-of-way dedications are proposed within stream buffer zones or adjacent to the outside of stream meanders as required by Water Services.
15. The developer shall submit plans to Land Development Division and obtain permits to construct sidewalks along the platted frontage, as shown on the approved street plans for \_\_\_\_\_ and to a tie-in point with the existing sidewalks at \_\_\_\_\_ and construct associated ADA ramps at the proposed entrance drives as necessary for the type of drive approach.
16. The developer shall submit a final stream buffer plan to the Land Development Division for approval prior to issuance of any building permits and obtain permits for the Stream Buffer prior to removal of any mature riparian species within the buffer zones due to construction activities on the site, in accordance with the Section 88-415 requirements.
17. The developer must design and construct all interior public streets to City Standards, as required by Chapter 88 and the Land Development Division, including curb and gutter, storm sewers, street lights, and sidewalks.
18. The developer must integrate into the existing street light system any relocated existing street lights within the street right-of-way impacted by the new drive or approach entrances as required by the Land Development Division, and the relocated lights must comply with all adopted lighting standards.
19. The developer must obtain the executed and recorded city approved grading, temporary construction, drainage/sewer, or any other necessary easements from the abutting property owner(s) that may be required prior to submitting any public improvements crossing properties not controlled by the developer and include said document(s) within the public improvement applications submitted for permitting
20. The developer must submit covenants, conditions and restrictions to the Land Development Division for review by the Law Department for approval and enter into covenant agreements for the maintenance of any private open space tracts with stream buffer zones or stormwater detention area tracts, prior to recording the plat.

*Condition(s) by Fire Department. Contact Michael Schroeder at (816) 513-4604 / michael.schroeder@kcmo.org with questions.*

21. • The project shall meet the fire flow requirements as set forth in Appendix B of the International Fire Code 2018. (IFC-2018 § 507.1)
22. Fire hydrant distribution shall follow IFC-2018 Table C102.1

Fire hydrants shall be installed and operable prior to the arrival of any combustible building materials onto the site. (IFC-2018 § 501.4 and 3312.1; NFPA -2013 § 8.7.2)

23. • A required fire department access roads shall be an all weather surface. (IFC-2012: § 503.2.3)
  - Fire Department access roads shall be provided prior to construction/demolition projects begin. (IFC-2018 § 501.4 and 3310.1; NFPA 241-2013 § 7.5.5)
  - Required fire department access roads shall designed to support a fire apparatus with gross axle weight of 85,000 pounds. (IFC-2018: § 503.2.3)
  - Shall provide fire lane signage on fire access drives.
24. • Dead end fire department access road(s) in excess of 150 feet shall be provided with an approved turn around feature (i.e., cul-de-sac, hammerhead). Dead-end streets in excess of 150 feet in length resulting from a “phased” project shall provide an approved temporary turn around feature (i.e., cul-de-sac, hammerhead). (IFC-2018: § 503.2.5)
  - The turning radius for fire department access roads shall be 30 feet inside and 50 feet outside radius. (IFC-2018: § 503.2.4)

*Condition(s) by Parks & Recreation. Contact Justin Peterson at (816) 513-7599 / Justin.Peterson@kcmo.org with questions.*



*Condition(s) by Parks & Recreation. Contact Justin Peterson at (816) 513-7599 / Justin.Peterson@kcmo.org with questions.*

25. The developer is responsible for dedication of parkland, private open space in lieu of parkland, or payment of cash-in-lieu of either form of dedication, or any combination thereof in accordance with 88-408. Should the developer choose to pay cash-in-lieu of dedicating all or a portion of the required area, the amount due shall be based upon the (2022) acquisition rate of (\$64,220.18) per acre. This requirement shall be satisfied prior to recording the final plat.
26. The developer shall submit a streetscape plan with street tree planting plan per 88-425-03 for approval by the Parks & Recreation Department's Forestry Division prior to beginning work in the public right-of-way.

*Condition(s) by Water Services Department. Contact Heather Massey at (816) 513-2111 / heather.massey@kcmo.org with questions.*

27. The developer shall ensure that water and fire service lines should meet current Water Services Department Rules and Regulations. Prior to C of O.  
<https://www.kcwater.us/wp-content/uploads/2022/05/2022-Rules-and-Regulations-for-Water-Service-Lines-Final.pdf>

*Condition(s) by Water Services Department. Contact Jerald Windsor at (816) 513-0413 / Jerald.Windsor@kcmo.org with questions.*

28. The developer must submit water main extension drawings prepared by a registered professional Engineer in Missouri to the main extension desk for review, acceptance and contracts per the KC Water Rules and Regulations for Water main extensions and Relocations.  
(<https://www.kcwater.us/wp-content/uploads/2022/05/2022-Rules-and-Regulations-for-Water-Main-Extensions-Final2.pdf>).

*Condition(s) by Water Services Department. Contact Lucas Kaspar at (816)513-2131 / Lucas.Kaspar@kcmo.org with questions.*

29. The developer must grant on City approved forms, a STREAM BUFFER Easement to the City, as required by Chapter 88 and Land Development Division, prior to issuance of any stream buffer permits.
30. The developer shall submit a Preliminary Stream Buffer plan prior to approval of the plan in accordance with the Section 88-415 requirements.

# SUMMIT VIEW FARMS

## DEVELOPMENT PLAN AND PRELIMINARY PLAT

### KANSAS CITY, JACKSON COUNTY, MISSOURI

#### PART OF NW 1/4 AND SW 1/4, SECTION 26, TOWNSHIP 47 N, RANGE 32 W

**INDEX OF SHEETS**

- 01 DEVELOPMENT PLAN AND PRELIMINARY PLAT COVER SHEET
- 02 OVERALL SITE
- 03 SITE PLAN – NORTH
- 04 SITE PLAN – SOUTH
- 05 UTILITY PLAN – NORTH
- 06 UTILITY PLAN – SOUTH
- 07 TYPICAL ROAD SECTIONS
- 08 PRELIMINARY STREAM BUFFER PLAN – OVERALL SITE
- 09 PRELIMINARY STREAM BUFFER PLAN – NORTH
- 10 PRELIMINARY STREAM BUFFER PLAN – SOUTH
- 11 ZONING MAP AMENDMENT
- 12 STREET NAME PLAN

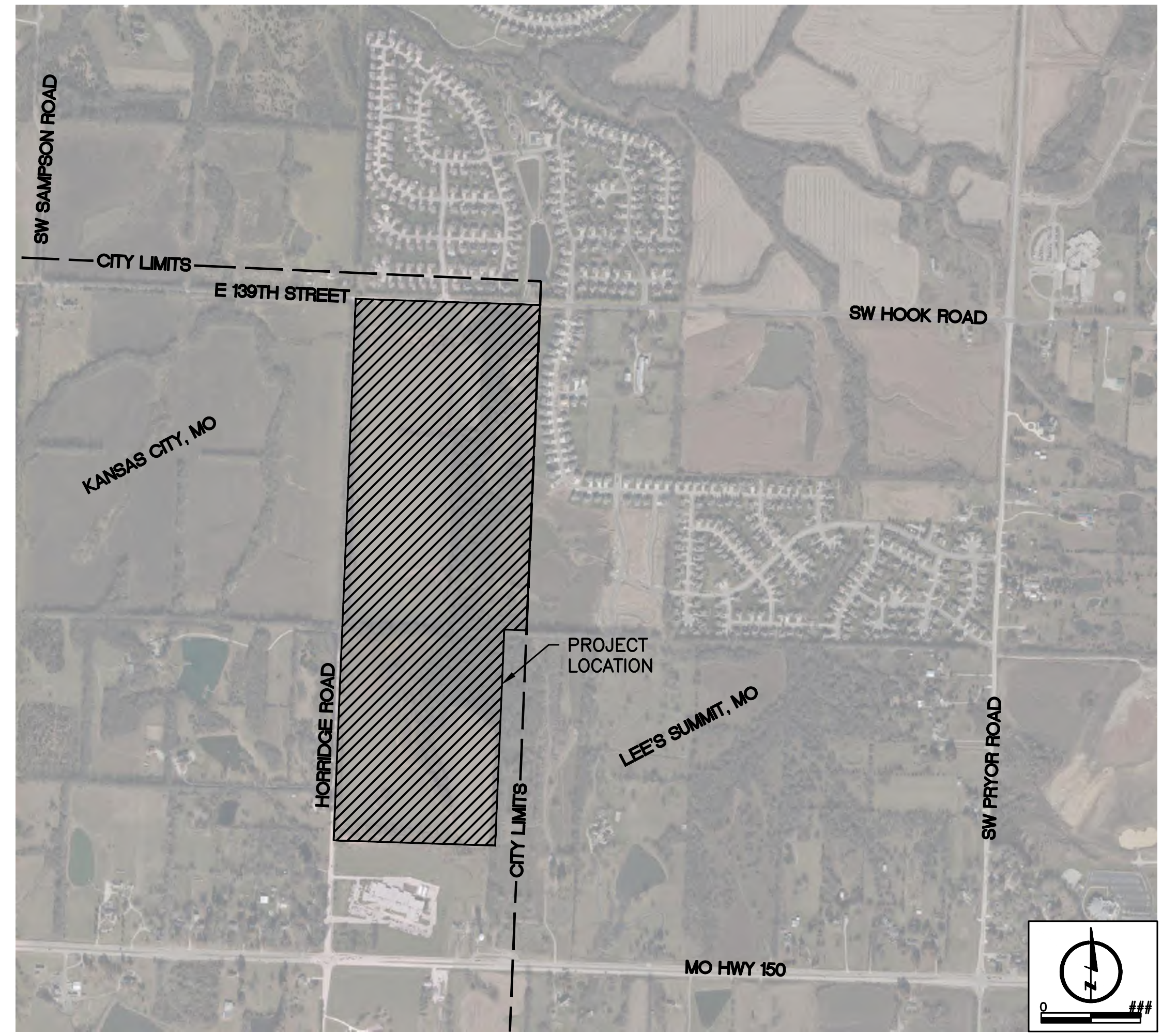

LOCATION MAP

U:\Projects\03191642 21025 1020 E:\Projects\03191642\CONSTRUCTION DRAWINGS\03191642 - CR.dwg, 11/16/2023 5:13:47 PM, BRADIE NALL, LAMP P/INTEGRATION

**LAMP  
RYNEARSON**

**OMAHA, NEBRASKA**  
 14710 W. DODGE RD., STE. 100 (402)496.2498  
**FORT COLLINS, COLORADO**  
 4715 INNOVATION DR., STE. 100 (970)226.0342  
**KANSAS CITY, MISSOURI**  
 9001 STATE LINE RD., STE. 200 (816)361.0440  
**LAMPRYNEARSON.COM**

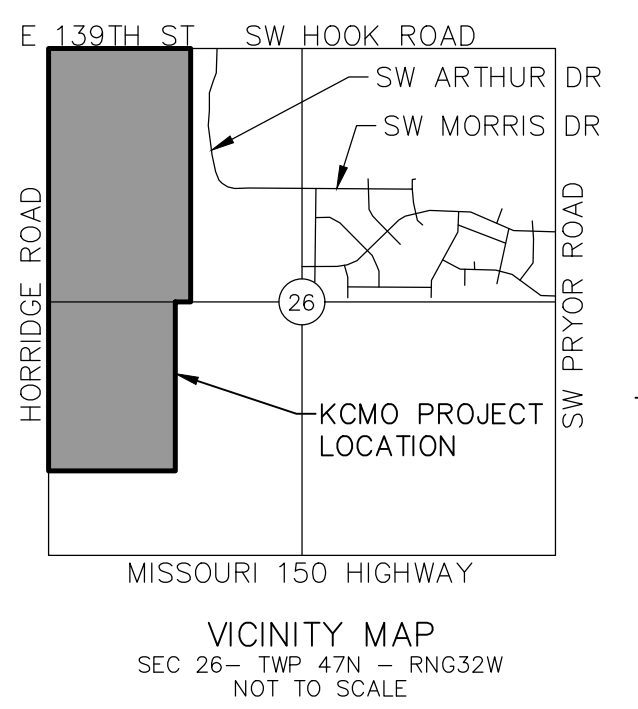

**SUMMIT VIEW FARMS**  
**DEVELOPMENT PLAN AND PRELIMINARY PLAT**  
 PART OF NW ¼ AND SW 1/4, SECTION 26, TOWNSHIP 47 NORTH,  
 RANGE 32 WEST  
 KANSAS CITY, JACKSON COUNTY, MISSOURI

**NOTES:**

1. PROPOSED REZONING IS FROM R-80 TO R-7.5.
2. PRELIMINARY KCMO LOT COUNT = 300 LOTS (SUBJECT TO FINAL DESIGN / ENGINEERING).
3. FOR EXISTING AND PROPOSED UTILITY LOCATIONS SEE SHEETS 4 & 5.
4. PROPOSED UTILITIES SUBJECT TO CHANGE ON A PER PLAT BASIS.
5. SIDEWALKS ARE PROPOSED ON ONE SIDE OF LOCAL STREETS AND BOTH SIDES OF COLLECTOR STREETS.
6. PHASES ARE ANTICIPATED TO BE CONSTRUCTED EVERY TWO YEARS, CONTINGENT ON MARKET CONDITIONS.
7. ONLY MINOR GRADING, SHRUBS, MULCH BEDS AND GRASS IS PROPOSED IN NO-BUILD TRACTS (EXISTING WATER TRANSMISSION MAIN EASEMENT.) NO BUILD AND LANDSCAPE TRACTS TO BE MAINTAINED BY THE HOMEOWNERS ASSOCIATION.

-- SUMMIT VIEW FARMS PRELIMINARY PLAT --  
 -- LEGAL DESCRIPTION --

All that part of the Northwest and Southwest Quarters of Section 26, Township 47 North, Range 32 West, situate in the City of Kansas City, Jackson County, Missouri, being described as follows:  
 Beginning at the Northwest corner of said Section 26; thence South 88°06'19" East, along the North line of said Section 26, a distance of 1,504.55 feet to the intersection with the North line of said Section 26 and the Northerly prolongation of the West line of SUMMIT VIEW FARMS AMENDED 1<sup>ST</sup> PLAT, a subdivision of record filed with the Jackson County, Missouri Register of Deeds as Instrument No. 2017E0048627, said line also being the city limit line between Kansas City, Missouri and Lee's Summit, Missouri; thence South 2'22'18" West, along the West line of said SUMMIT VIEW FARMS AMENDED 1<sup>ST</sup> PLAT and its Northerly prolongation and also along the West line of SUMMIT VIEW FARMS 4<sup>TH</sup> PLAT, a subdivision of record filed with said Register of Deeds as Instrument No. 2022E0006745, a distance of 1,624.62 feet; thence South 2'21'56" West, continuing along the West line of said SUMMIT VIEW FARMS 4<sup>TH</sup> PLAT, a distance of 1,033.59 feet to the Southwest plat corner thereof, said point also being on the North line of the Southwest Quarter of said Section 26; thence North 87°59'47" West, along the North line of the Southwest Quarter of said Section 26, a distance of 179.92 feet to a point on the East line of the West Half thereof; thence South 2'23'27" West, along the East line of the West Half of the Southwest Quarter of said Section 26, a distance of 1,766.36 feet to the Northeast corner of the plat of LEE'S SUMMIT ELEMENTARY SCHOOL NO. 17, a subdivision of record filed with said Register of Deeds as Instrument No. 2007E0094456; thence North 88°09'04" West, along the North line of said LEE'S SUMMIT ELEMENTARY SCHOOL NO. 17 and its Westerly prolongation, a distance of 1,318.91 feet to a point on the West line of the Southwest Quarter of said Section 26; thence North 2'18'40" East, along the West line of the Southwest Quarter of said Section 26, a distance of 1,769.90 feet to the Southwest corner of the Northwest Quarter of said Section 26; thence North 2'17'56" East, along the West line of the Northwest Quarter of said Section 26, a distance of 2,655.32 feet to the Point of Beginning.  
 Containing 6,326,781 square feet or 145.24 acres, more or less.  
 The bearings in this description are based on the Missouri Coordinate System of 1983, West Zone, NAD83.

**LEGEND**

- SINGLE FAMILY RESIDENTIAL  
72'x120' MIN LOT DIMENSION
- SINGLE FAMILY RESIDENTIAL  
(MAINTENANCE PROVIDED)  
60'x120' MIN LOT DIMENSION
- 30' NO-BUILD/LANDSCAPE TRACT  
(AS NOTED ON PLAN)
- MONUMENT SIGN TRACT
- PROPOSED ROW DEDICATION
- SECTION LINES
- N/F NOW OR FORMERLY
- EXISTING STREAM BUFFER EXTENT  
(REFER TO STREAM BUFFER PLANS)

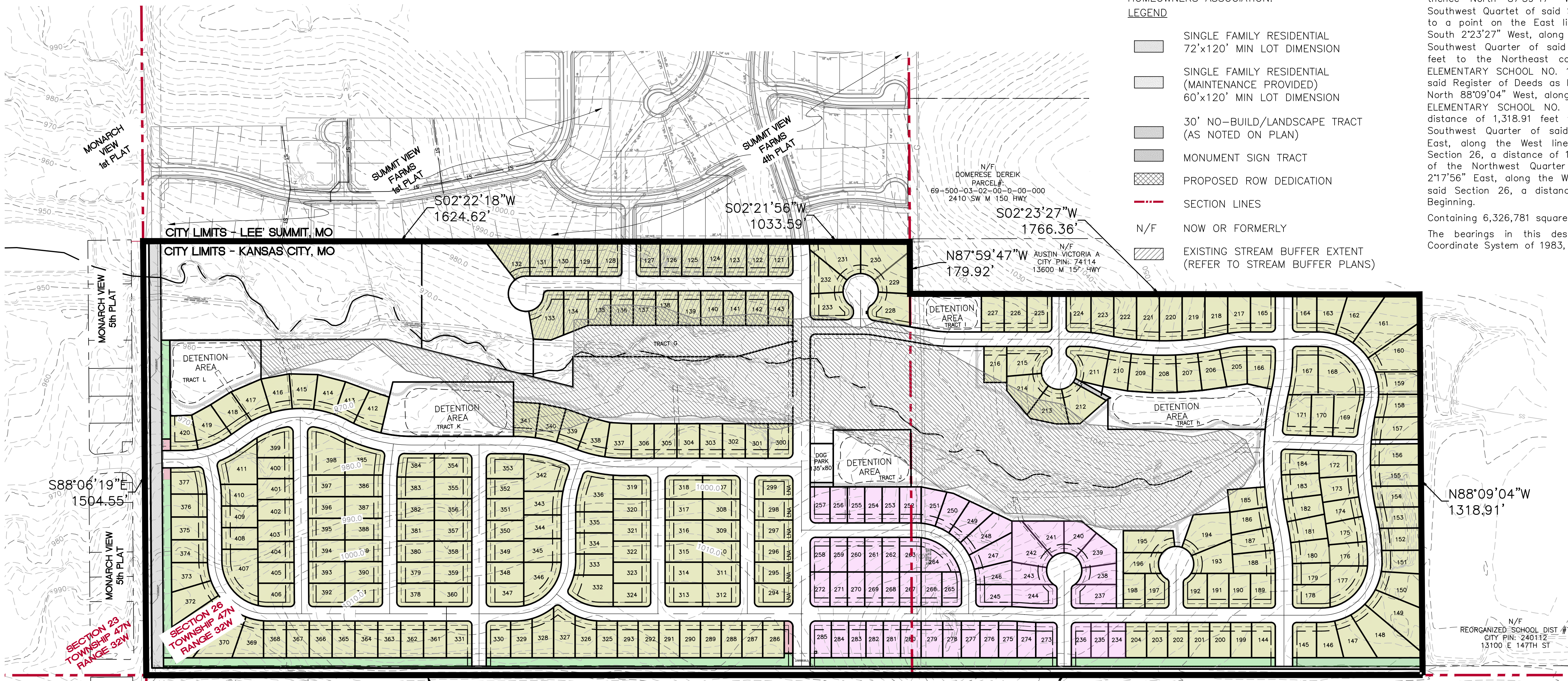

N/F MOTHERSBAUGH WILLIS F & DIXIE TRUSTEES CITY PIN: 240332 13001 E 139TH ST  
 N/F HANN CLARA ELIZABETH CITY PIN: 240333 12501 E 139TH ST  
 N/F MOTHERSBAUGH WILLIS F & DIXIE TRUSTEES CITY PIN: 240334 (NO ADDRESS)  
 N/F STOUT MICHAEL L & KIMBERLY S CITY PIN: 74121 14400 HORRIDGE RD  
 N/F JOSEPH L & PAMELA J CITY PIN: 74135 14500 HORRIDGE RD  
 N/F CLARK DOUGLAS D CITY PIN: 74127 13016 E 147TH ST  
 N/F GATTENBY GARY LEE & DEBORAH ANN CITY PIN: 74128 13012 E 147TH ST  
 N/F STOUT MICHAEL L & KIMBERLY S CITY PIN: 74124 14300 HORRIDGE RD  
 N/F ALDY DENNIS & DARA D CITY PIN: 261291 14440 HORRIDGE RD

SITE DATA	Existing	Proposed	Deviation Requested?	Approved
ZONING	R-80	R-7.5	N	
GROSS LAND AREA				
In SF	6,326,781	6,326,781		
In AC	145.24	145.24		
RIGHT OF WAY DEDICATION				
In SF	129,462	1,223,412		
In AC	2.97	28.09		
NET LAND AREA				
In SF	6,197,319	5,103,369		
In AC	142.27	117.16		
BUILDING AREA	N/A, Single Family Residential			
FLOOR AREA RATIO	N/A, Single Family Residential			
RESIDENTIAL USE INFO				
Total Dwelling Units	0	300	N	
Detached House	0	300	N	
Total Lots	0	300	N	
Residential Lots	0	300	N	
Commercial Lots	0	0	N	
Industrial Lots	0	0	N	
Other Lots	0	0	N	

BUILDING DATA	REQUIRED	PROPOSED	DEVIATION REQUESTED?	APPROVED
REAR SETBACK	30	30	N	
FRONT SETBACK	30	30	N	
SIDE SETBACK	8	8	N	
SIDE SETBACK (abutting street)	15	15	N	
HEIGHT	35	35	N	

PHASE	LAND USE TYPE	NUMBER OF DWELLINGS	*PARKLAND DEDICATION REQUIRED (AC)	LENGTH OF TRAIL (FT)	PARKLAND DEDICATION =(LENGTH OF TRAIL*50)/43,560 (AC)
1	Single Family	23	0.511	0	0.000
2	Single Family	41	0.910	745	0.855
3	Single Family	60	1.332	1824	2.094
4**	Single Family	41	0.910	722	0.829
5	Single Family	39	0.866	600	0.688
6	Single Family	36	0.799	865	0.993
7	Single Family	60	1.332	1339	1.537
<b>TOTAL</b>		<b>300</b>	<b>6.660</b>	<b>6095</b>	<b>7.246</b>

\*NOTE: Parkland Dedication Required Calculated by multiplying number of Dwellings \* 0.006 \*3.7  
 \*\*NOTE: Phase 4 contains a Dog Park (10,800 SF, 0.25 AC)  
 Final Trail Length Subject to Final Design on a Per Plat Basis

**DEVELOPER**  
 SUMMIT VIEW FARMS DEVELOPMENT GROUP, LLC  
 P.O. BOX 291  
 LEE'S SUMMIT, MO 64063  
**BILL KENNEY**  
 (816) 838-0552  
**ENGINEER/SURVEYOR**  
 LAMP RYNEARSON, INC.  
 9001 STATE LINE ROAD, SUITE 200  
 KANSAS CITY, MO 64114  
**DAN MCGHEE**  
 (816) 361-0440

**LAMP RYNEARSON**  
 LAMP RYNEARSON, INC.  
 OMAHA, NEBRASKA  
 14710 W. DODGE RD., STE. 100 (402) 496-2498  
 FORT COLLINS, COLORADO  
 4715 INNOVATION DR., STE. 100 (970) 226-0342  
 KANSAS CITY, MISSOURI  
 9001 STATE LINE RD., STE. 200 (816) 361-0440

PRELIMINARY  
 NOT RELEASED FOR CONSTRUCTION

SUMMIT VIEW FARMS  
 PRELIMINARY PLAT  
 OVERALL SITE  
 KANSAS CITY, JACKSON COUNTY, MISSOURI

Know what's below.  
 Call before you dig.  
**REVISIONS**  
 11/18/2022 - PER CITY COMMENTS

**DESIGNER / DRAFTER**  
 BRANCE NEAL  
**DATE**  
 JULY, 2022  
**PROJECT NUMBER**  
 0319042  
**BOOK AND PAGE**  
 SHEET

2

U:\09\09\0319042\_0002\_0240\_00000000\09\09\0319042\_0002\_0240\_00000000.dwg - P:\09\09\0319042\_0002\_0240\_00000000.dwg - P:\09\09\0319042\_0002\_0240\_00000000.dwg

SUMMIT VIEW FARMS  
DEVELOPMENT PLAN AND PRELIMINARY PLAT

PART OF NW ¼ AND SW 1/4, SECTION 26, TOWNSHIP 47 NORTH,  
RANGE 32 WEST

KANSAS CITY, JACKSON COUNTY, MISSOURI

- LEGEND**
- SINGLE FAMILY RESIDENTIAL  
72'x120' MIN LOT DIMENSION
  - SINGLE FAMILY RESIDENTIAL  
(MAINTENANCE PROVIDED)  
60'x120' MIN LOT DIMENSION
  - 30' NO-BUILD/LANDSCAPE TRACT  
(AS NOTED ON PLAN)
  - MONUMENT SIGN TRACT
  - PROPOSED ROW DEDICATION
  - SECTION LINES
  - N/F NOW OR FORMERLY
  - EXISTING STREAM BUFFER EXTENT  
(REFER TO STREAM BUFFER PLANS)
  - LOTS SERVED BY LEE'S SUMMIT WATER
  - WALKING TRAIL

**LAMP  
RYNEARSON**

LAMPRYNEARSON.COM

OMAHA, NEBRASKA  
14710 W. DODGE RD., STE. 100 (402)496.2498  
FORT COLLINS, COLORADO  
4715 INNOVATION DR., STE. 100 (970)228.0342  
KANSAS CITY, MISSOURI  
8001 STATE LINE RD., STE. 200 (816)351.0440

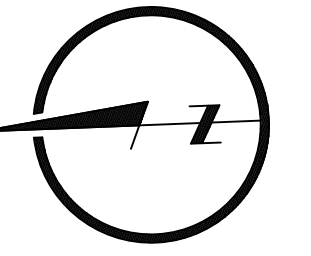

0 100 200

PRELIMINARY

NOT RELEASED FOR CONSTRUCTION

SUMMITVIEW FARMS  
PRELIMINARY PLAT  
SITE PLAN - NORTH

KANSAS CITY, JACKSON COUNTY, MISSOURI



Know what's below.  
Call before you dig.

REVISIONS  
11/18/2022 - PER CITY COMMENTS

DESIGNER / DRAFTER  
BRANCE NEAL  
DATE  
JULY, 2022  
PROJECT NUMBER  
0319042  
BOOK AND PAGE

SHEET

3

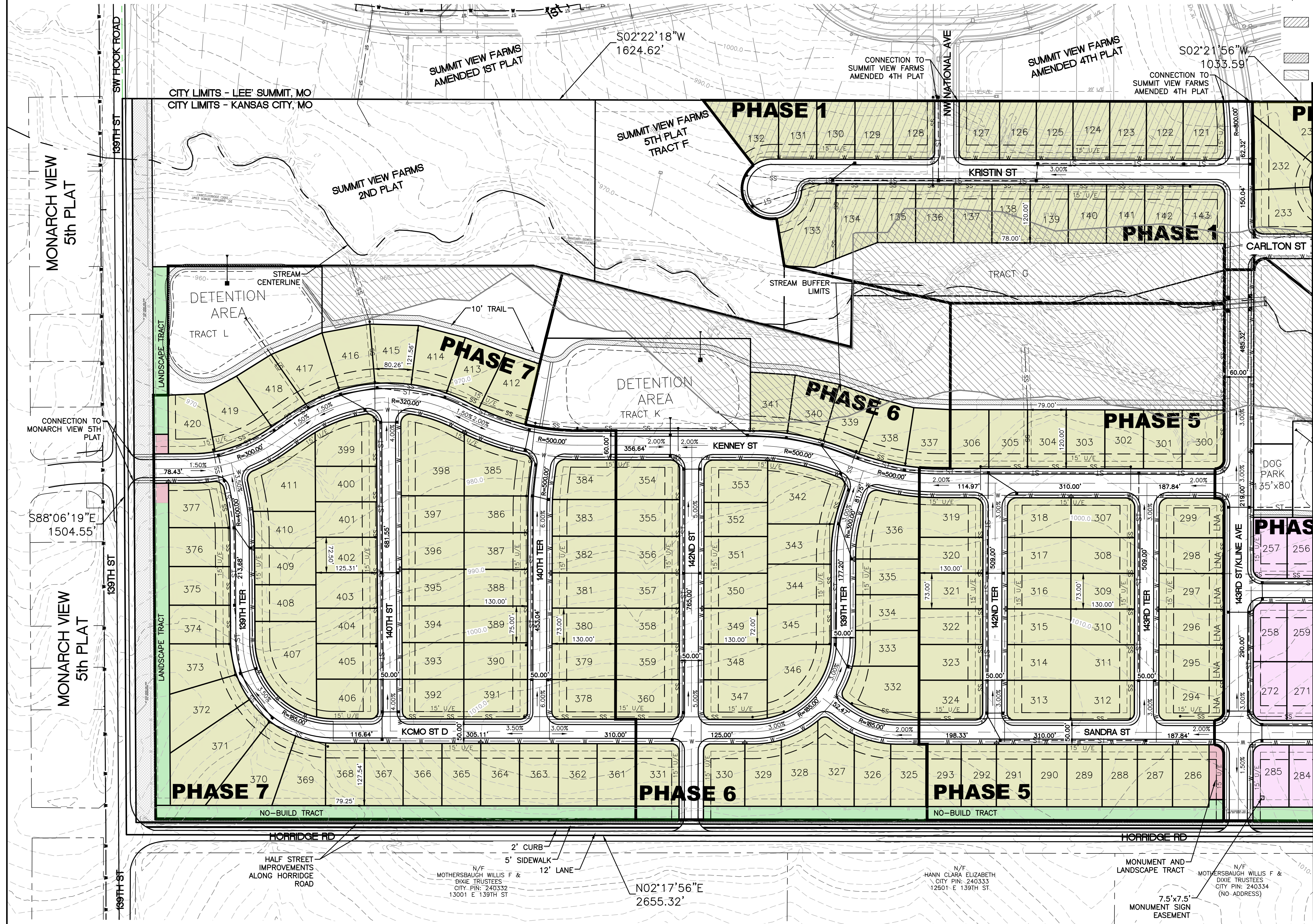

MATCHLINE SEE SHEET 3

U:\0319042\0319042\_0002\_KC40\_02000001\0319042\_0002\_0319042\_Prelim.plt (BRANCE NEAL, LAMP RYNEARSON)

SUMMIT VIEW FARMS  
DEVELOPMENT PLAN AND PRELIMINARY PLAT

PART OF NW 1/4 AND SW 1/4, SECTION 26, TOWNSHIP 47 NORTH,  
RANGE 32 WEST  
KANSAS CITY, JACKSON COUNTY, MISSOURI

- LEGEND**
- SINGLE FAMILY RESIDENTIAL  
72'x120' MIN LOT DIMENSION
  - SINGLE FAMILY RESIDENTIAL  
(MAINTENANCE PROVIDED)  
60'x120' MIN LOT DIMENSION
  - 30' NO-BUILD/LANDSCAPE TRACT  
(AS NOTED ON PLAN)
  - MONUMENT SIGN TRACT
  - PROPOSED ROW DEDICATION
  - SECTION LINES
  - N/F NOW OR FORMERLY
  - EXISTING STREAM BUFFER EXTENT  
(REFER TO STREAM BUFFER PLANS)
  - LOTS SERVED BY LEE'S SUMMIT WATER
  - WALKING TRAIL

**LAMP RYNEARSON**  
LAMP RYNEARSON, COM  
OMAHA, NEBRASKA  
14710 W. DODGE RD., STE. 100 (402)496.2498  
FORT COLLINS, COLORADO  
4715 INNOVATION DR., STE. 100 (970)228.0342  
KANSAS CITY, MISSOURI  
8001 STATE LINE RD., STE. 200 (816)351.0440

PRELIMINARY  
NOT RELEASED FOR CONSTRUCTION

SUMMIT VIEW FARMS  
PRELIMINARY PLAT  
SITE PLAN - SOUTH  
KANSAS CITY, JACKSON COUNTY, MISSOURI

Know what's below.  
Call before you dig.

**REVISIONS**  
11/18/2022 - PER CITY COMMENTS

**DESIGNER / DRAFTER**  
BRANCE NEAL  
**DATE**  
JULY, 2022  
**PROJECT NUMBER**  
0319042  
**BOOK AND PAGE**

**SHEET**  
4

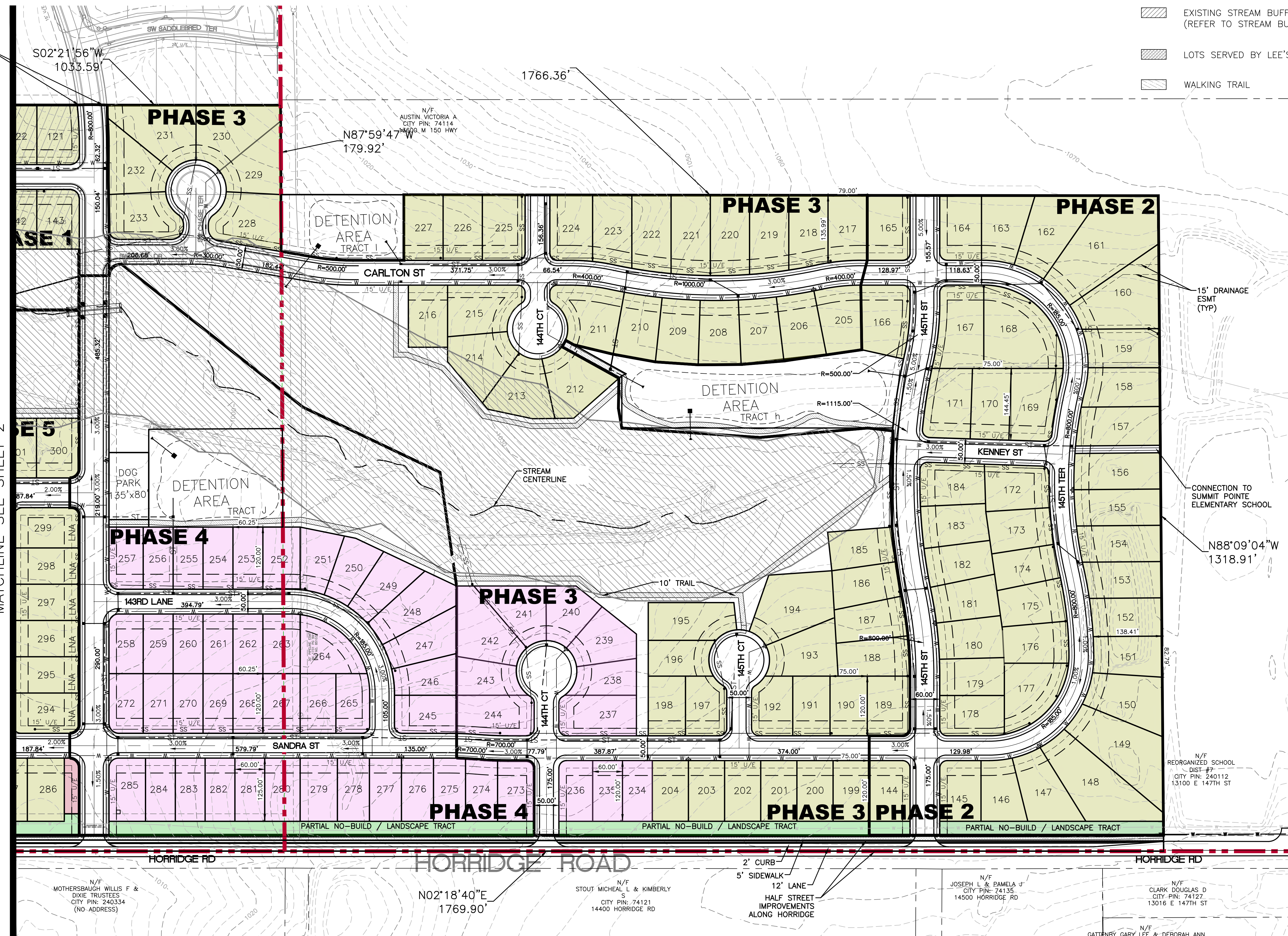

CONNECTION TO  
SUMMIT VIEW FARMS  
AMENDED 4TH PLAT

MATCHLINE SEE SHEET 2

15' DRAINAGE  
ESMT  
(TYP)

CONNECTION TO  
SUMMIT POINTE  
ELEMENTARY SCHOOL

N/F  
REORGANIZED SCHOOL  
DIST #77  
CITY PIN: 240112  
13100 E 147TH ST

N/F  
MOTHERSBAUGH WILLIS F &  
DIXIE TRUSTEES  
CITY PIN: 240334  
(NO ADDRESS)

N/F  
STOUT MICHAEL L & KIMBERLY  
S  
CITY PIN: 74121  
14400 HORRIDGE RD

N/F  
JOSEPH L & EAMELA J  
CITY PIN: 74135  
14500 HORRIDGE RD

N/F  
CLARK DOUGLAS D  
CITY PIN: 74127  
13016 E 147TH ST

N/F  
CATTENRY GARY LFF & DEBORAH ANN

U:\09\mry\0319042\0319042\_0240.dwg (2022/07/11 11:17:02) 2/28/24 PL BRANCE NEAL LAMP RYNEARSON

SUMMIT VIEW FARMS  
DEVELOPMENT PLAN AND PRELIMINARY PLAT

PART OF NW ¼ AND SW 1/4, SECTION 26, TOWNSHIP 47 NORTH,  
RANGE 32 WEST

KANSAS CITY, JACKSON COUNTY, MISSOURI

- LEGEND**
- SANITARY SEWER
  - STORM SEWER
  - WATERLINE
  - ◆ FIRE HYDRANT
  - ▨ LOTS SERVED BY LEE'S SUMMIT WATER

**LAMP  
RYNEARSON**

LAMPRYNEARSON.COM

OMAHA, NEBRASKA  
14710 W. DODGE RD., STE. 100 (402)496.2498  
FORT COLLINS, COLORADO  
4715 INNOVATION DR., STE. 100 (970)226.0342  
KANSAS CITY, MISSOURI  
8001 STATE LINE RD., STE. 200 (816)351.0440

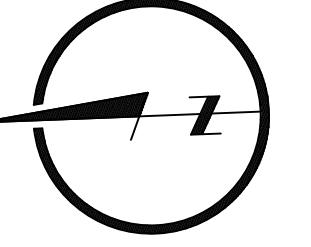

0 100 200

PRELIMINARY

NOT RELEASED FOR CONSTRUCTION

SUMMIT VIEW FARMS  
PRELIMINARY PLAT  
UTILITY PLAN - NORTH

KANSAS CITY, JACKSON COUNTY, MISSOURI

MATCHLINE SEE SHEET 3

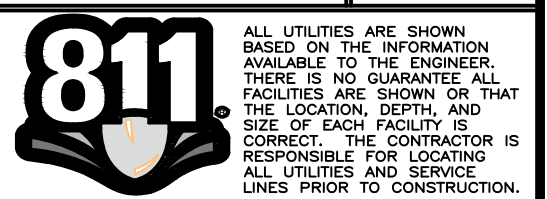
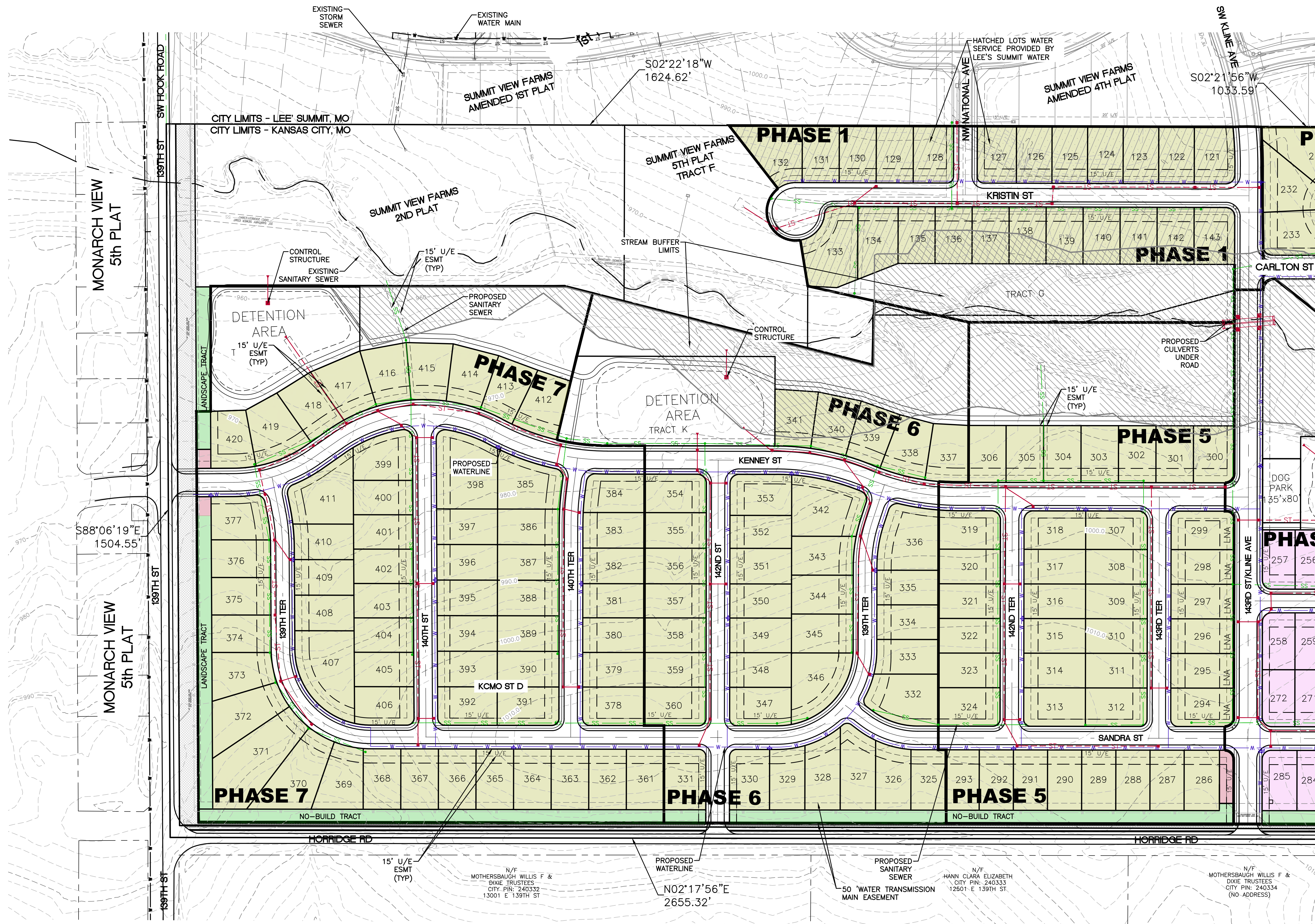

Know what's below.  
Call before you dig.

REVISIONS  
11/18/2022 - PER CITY COMMENTS

DESIGNER / DRAFTER  
BRANCE NEAL  
DATE  
JULY, 2022  
PROJECT NUMBER  
0319042  
BOOK AND PAGE

SHEET

U:\Projects\0319042\0319042\_0319042\_0319042\_0319042 - Prelim.plat.dwg 11/18/2022 2:27:15 PM BRANCE NEAL LAMP RYNEARSON

SUMMIT VIEW FARMS  
DEVELOPMENT PLAN AND PRELIMINARY PLAT

PART OF NW ¼ AND SW 1/4, SECTION 26, TOWNSHIP 47 NORTH,  
RANGE 32 WEST  
KANSAS CITY, JACKSON COUNTY, MISSOURI

- LEGEND**
- SANITARY SEWER
  - STORM SEWER
  - WATERLINE
  - ◆ FIRE HYDRANT

**LAMP RYNEARSON**  
LAMPRYNEARSON.COM  
OMAHA, NEBRASKA  
14710 W. DODGE RD., STE. 100 (402)496.2498  
FORT COLLINS, COLORADO  
4715 INNOVATION DR., STE. 100 (970)228.0342  
KANSAS CITY, MISSOURI  
8001 STATE LINE RD., STE. 200 (816)351.0440

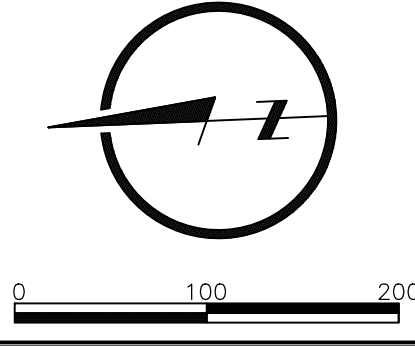

PRELIMINARY

NOT RELEASED FOR CONSTRUCTION

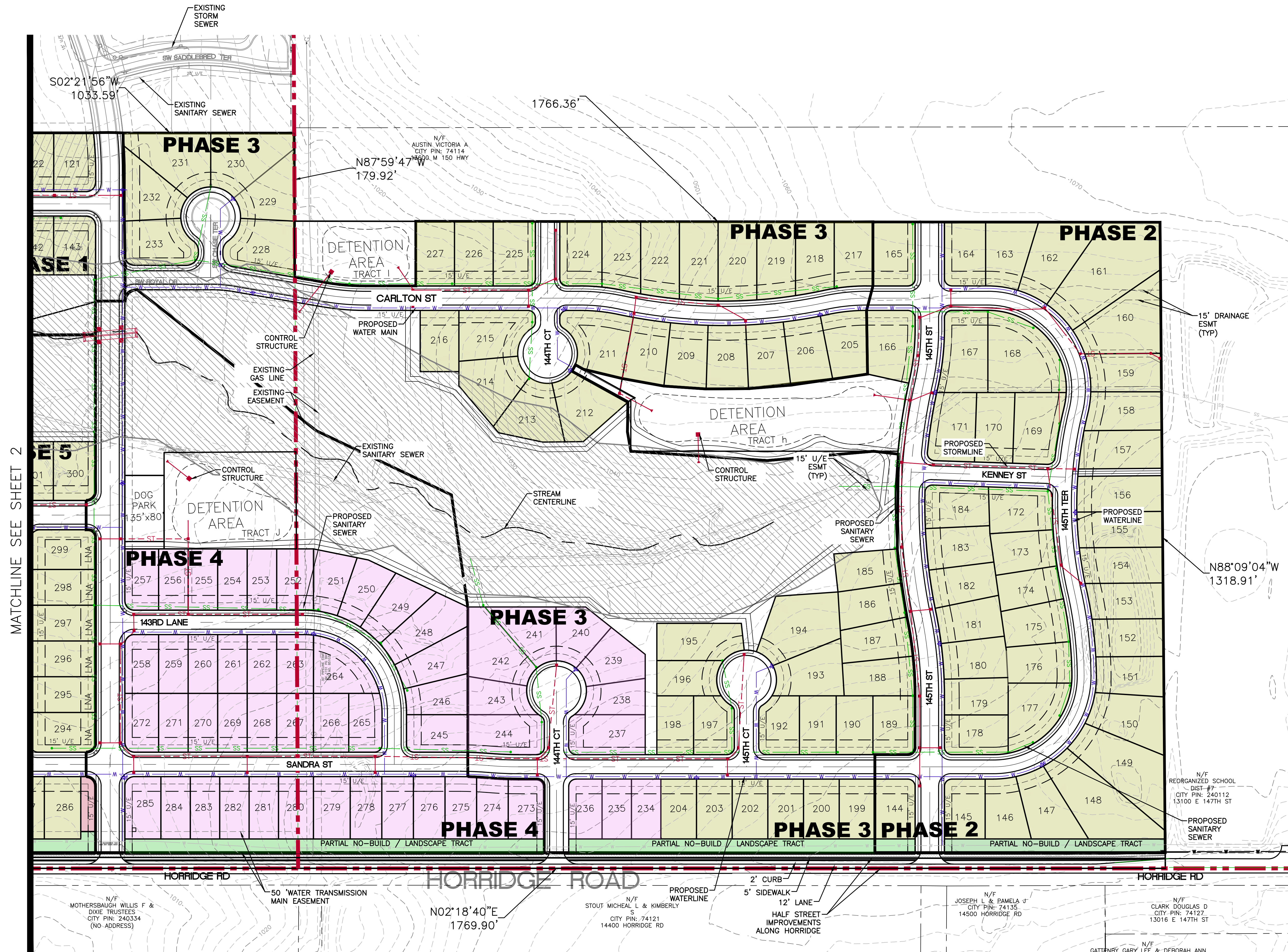

SUMMIT VIEW FARMS  
PRELIMINARY PLAT  
UTILITY PLAN - SOUTH

KANSAS CITY, JACKSON COUNTY, MISSOURI

**811**  
Know what's below.  
Call before you dig.

REVISIONS  
11/18/2022 - PER CITY COMMENTS

DESIGNER / DRAFTER  
BRANCE NEAL  
DATE  
JULY, 2022  
PROJECT NUMBER  
0319042  
BOOK AND PAGE

SHEET  
6

U:\Projects\0319042\0319042\_0300\_0300\_0300.dwg - 11/18/2022 10:23:37 AM - BRANCE NEAL, LAMP RYNEARSON

SUMMIT VIEW FARMS  
 DEVELOPMENT PLAN AND PRELIMINARY PLAT  
 PART OF NW ¼ AND SW ¼, SECTION 26, TOWNSHIP 47 NORTH,  
 RANGE 32 WEST  
 KANSAS CITY, JACKSON COUNTY, MISSOURI

**LAMP  
RYNEARSON**

LAMPRYNEARSON.COM

OMAHA, NEBRASKA  
 14710 W. DODGE RD., STE. 100 (402)496.2498  
 FORT COLLINS, COLORADO  
 4715 INNOVATION DR., STE. 100 (970)226.0342  
 KANSAS CITY, MISSOURI  
 9001 STATE LINE RD., STE. 200 (816)351.0440

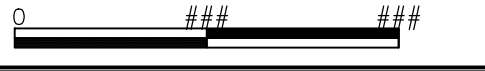
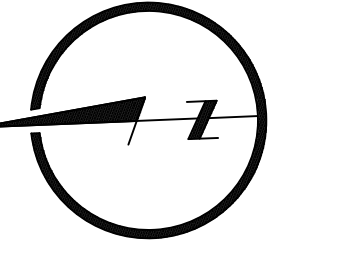

PRELIMINARY

NOT RELEASED FOR CONSTRUCTION

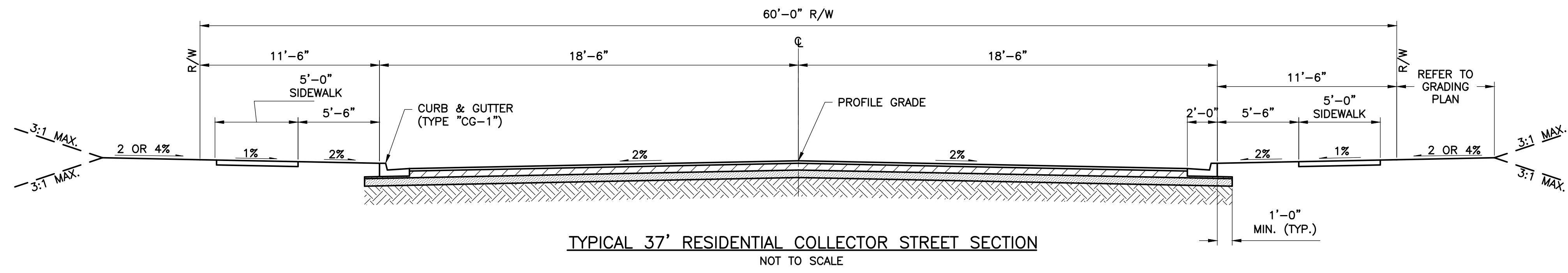

TYPICAL 37' RESIDENTIAL COLLECTOR STREET SECTION  
 NOT TO SCALE

**GENERAL NOTES**

1. CONSTRUCT ADA COMPLIANT SIDEWALK (OR SHARED USE PATH) ON EACH SIDE OF COLLECTOR STREETS.
2. CONSTRUCT ADA COMPLIANT SIDEWALK (OR SHARED USE PATH) ON ONE SIDE OF RESIDENTIAL LOCAL STREETS.

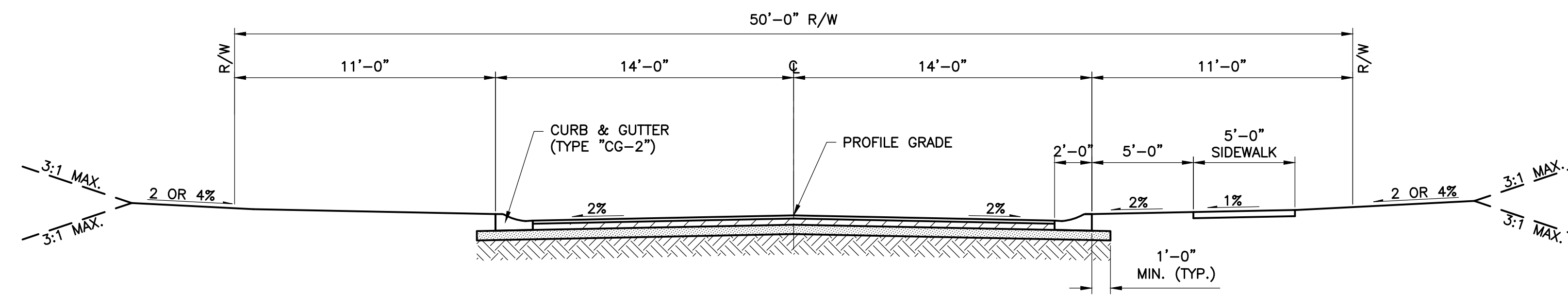

TYPICAL 28' RESIDENTIAL LOCAL STREET SECTION  
 NOT TO SCALE

SUMMIT VIEW FARMS  
 PRELIMINARY PLAT  
 TYPICAL ROAD SECTIONS

KANSAS CITY, JACKSON COUNTY, MISSOURI



ALL UTILITIES ARE SHOWN  
 BASED ON THE INFORMATION  
 AVAILABLE TO THE ENGINEER.  
 THERE IS NO GUARANTEE AS TO  
 THE LOCATION, DEPTH, AND  
 SIZE OF EACH FACILITY. THE  
 CONTRACTOR IS RESPONSIBLE FOR  
 VERIFYING ALL UTILITIES AND  
 MARKING LINES PRIOR TO CONSTRUCTION.

**REVISIONS**

11/18/2022	- PER CITY COMMENTS

DESIGNER / DRAFTER	BRANCE NEAL
DATE	JULY, 2022
PROJECT NUMBER	0319042
BOOK AND PAGE	

U:\p\p\p\0319042\_01002\_0200\_0000\0319042\_01002\_0200\_0000.dwg - P:\p\p\p\0319042 - P\p\p\p\0319042 - P\p\p\p\0319042.dwg



SUMMIT VIEW FARMS

DEVELOPMENT PLAN AND PRELIMINARY PLAT

PART OF NW ¼ AND SW 1/4, SECTION 26, TOWNSHIP 47 NORTH, RANGE 32 WEST

KANSAS CITY, JACKSON COUNTY, MISSOURI

NOTE: A WAIVER REQUEST WILL BE SUBMITTED TO TERMINATE THE SOUTHERN EXTENT OF THE STREAM BUFFER AS SHOWN ON THESE PLANS

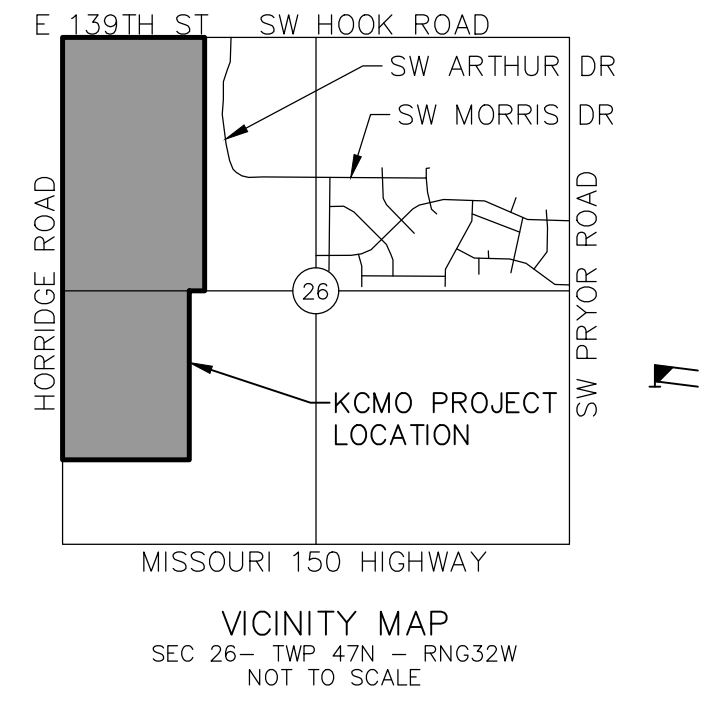

LAMP RYNEARSON logo and contact information for Omaha, Nebraska and Fort Collins, Colorado.

Preliminary title block containing a north arrow, scale bar, and the text 'PRELIMINARY' and 'NOT FOR CONSTRUCTION'.

-- SUMMIT VIEW FARMS PRELIMINARY PLAT LEGAL --  
-- DESCRIPTION --

All that part of the Northwest and Southwest Quarters of Section 26, Township 47 North, Range 32 West, situate in the City of Kansas City, Jackson County, Missouri, being described as follows:

Beginning at the Northwest corner of said Section 26; thence South 88°06'19" East, along the North line of said Section 26, a distance of 1,504.55 feet to the intersection with the North line of said Section 26 and the Northerly prolongation of the West line of SUMMIT VIEW FARMS AMENDED 1ST PLAT, a subdivision of record filed with the Jackson County, Missouri Register of Deeds as Instrument No. 2017E0048627, said line also being the city limit line between Kansas City, Missouri and Lee's Summit, Missouri; thence South 2°22'18" West, along the West line of said SUMMIT VIEW FARMS AMENDED 1ST PLAT and its Northerly prolongation and also along the West line of SUMMIT VIEW FARMS 4TH PLAT, a subdivision of record filed with said Register of Deeds as Instrument No. 2022E0006745, a distance of 1,624.62 feet; thence South 2°21'56" West, continuing along the West line of said SUMMIT VIEW FARMS 4TH PLAT, a distance of 1,033.59 feet to the Southwest plot corner thereof, said point also being on the North line of the Southwest Quarter of said Section 26; thence North 87°59'47" West, along the North line of the Southwest Quarter of said Section 26, a distance of 179.92 feet to a point on the East line of the West Half thereof; thence South 2°23'27" West, along the East line of the West Half of the Southwest Quarter of said Section 26, a distance of 1,766.36 feet to the Northeast corner of the plat of LEE'S SUMMIT ELEMENTARY SCHOOL NO. 17, a subdivision of record filed with said Register of Deeds as Instrument No. 2007E0094456; thence North 88°09'04" West, along the North line of said LEE'S SUMMIT ELEMENTARY SCHOOL NO. 17 and its Westerly prolongation, a distance of 1,318.91 feet to a point on the West line of the Southwest Quarter of said Section 26; thence North 2°18'40" East, along the West line of the Southwest Quarter of said Section 26, a distance of 1,769.90 feet to the Southwest corner of the Northwest Quarter of said Section 26; thence North 217°56" East, along the West line of the Northwest Quarter of said Section 26, a distance of 2,655.32 feet to the Point of Beginning.

Containing 6,326,781 square feet or 145.24 acres, more or less.

The bearings in this description are based on the Missouri Coordinate System of 1983, West Zone, NAD83.

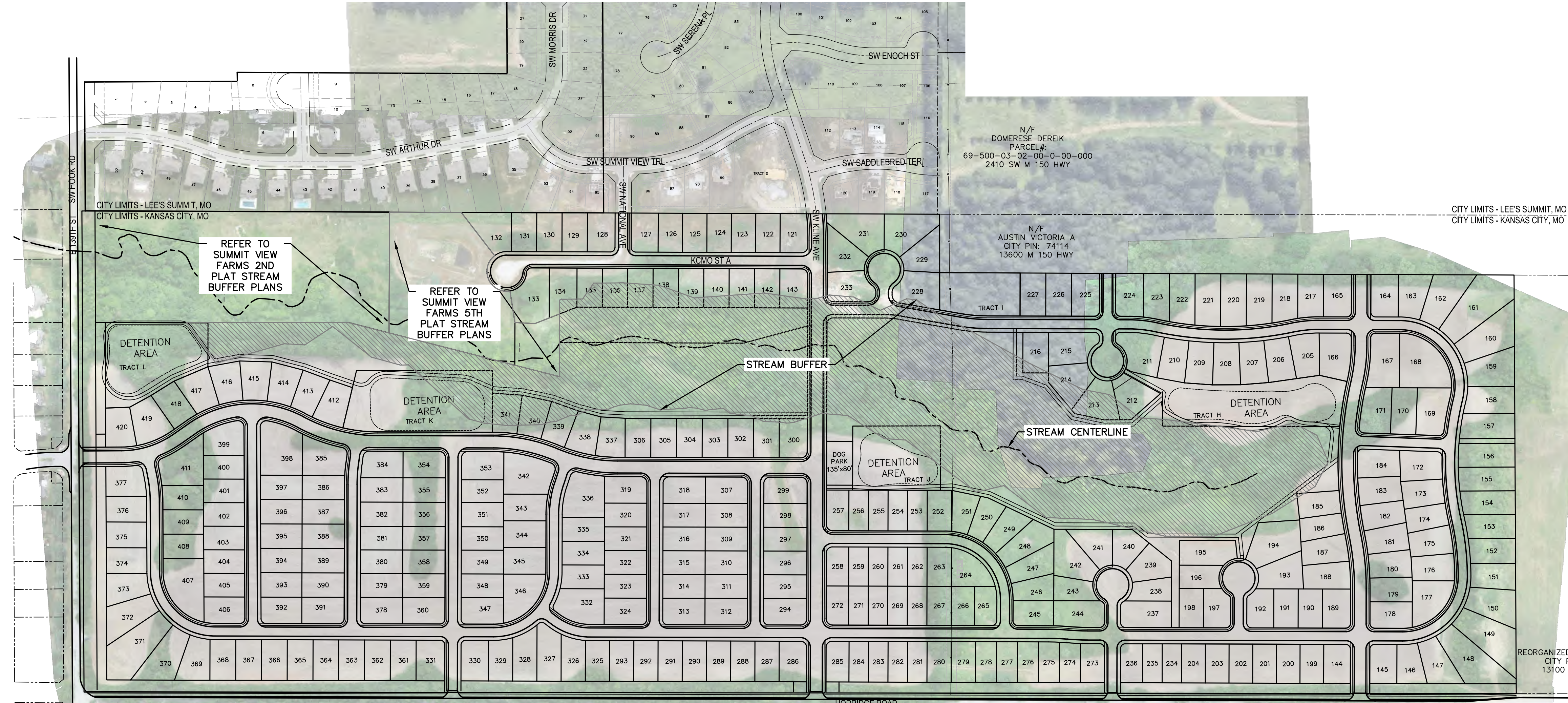

SUMMIT VIEW FARMS  
PRELIMINARY STREAM BUFFER PLAN  
OVERALL SITE  
KANSAS CITY, JACKSON COUNTY, MISSOURI

REFER TO SUMMIT VIEW FARMS 2ND PLAT STREAM BUFFER PLANS

REFER TO SUMMIT VIEW FARMS 5TH PLAT STREAM BUFFER PLANS

STREAM BUFFER

STREAM CENTERLINE

DETECTION AREA TRACT L

DETECTION AREA TRACT K

DETECTION AREA TRACT J

DETECTION AREA TRACT H

N/F MOTHERSBAUGH WILLIS F & DIXIE TRUSTEES  
CITY PIN: 240332  
13001 E 139TH ST

N/F HANN CLARA ELIZABETH  
CITY PIN: 240333  
12501 E 139TH ST

N/F MOTHERSBAUGH WILLIS F & DIXIE TRUSTEES  
CITY PIN: 240334  
(NO ADDRESS)

N/F STOUT MICHAEL L & KIMBERLY S  
CITY PIN: 74121  
14400 HORRIDGE RD

N/F JOSEPH L & PAMELA  
CITY PIN: 74135  
14500 HORRIDGE RD

N/F CLARK DOUGLAS D  
CITY PIN: 74127  
13016 E 147TH ST

N/F STOUT MICHAEL L & KIMBERLY S  
CITY PIN: 74124  
14300 HORRIDGE RD

N/F ALDY DENNIS & DARA D  
CITY PIN: 261291  
14440 HORRIDGE RD

N/F GATTENBY GARY LEE & DEBORAH ANN  
CITY PIN: 74128  
13012 E 147TH ST

N/F REORGANIZED SCHOOL DIST #7  
CITY PIN: 240112  
13100 E 147TH ST

Small vertical text at the bottom left corner of the page.

811 logo and revision table with columns for date and description.

SUMMIT VIEW FARMS  
 DEVELOPMENT PLAN AND PRELIMINARY PLAT  
 PART OF NW ¼ AND SW 1/4, SECTION 26, TOWNSHIP 47 NORTH,  
 RANGE 32 WEST  
 KANSAS CITY, JACKSON COUNTY, MISSOURI

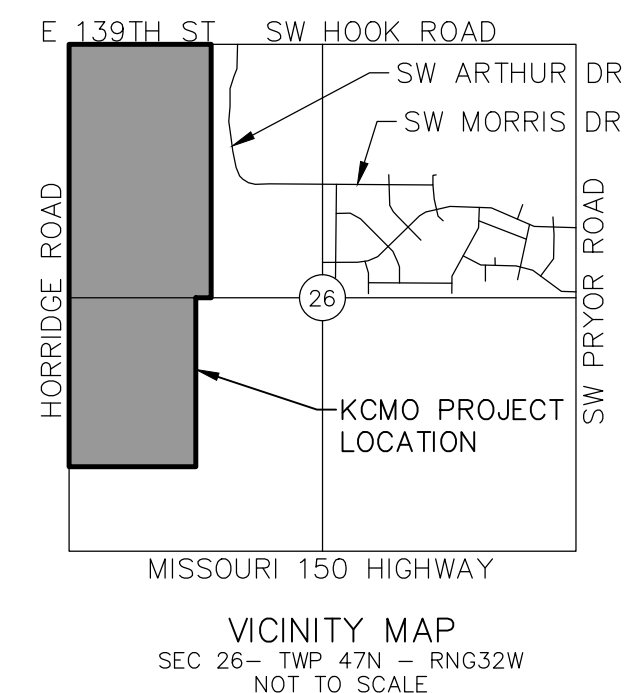

**LAMP RYNEARSON**  
 LAMPRYNEARSON.COM  
 OMAHA, NEBRASKA  
 14710 W. DODGE RD., STE. 100 (402)496.2498  
 FORT COLLINS, COLORADO  
 4715 INNOVATION DR., STE. 100 (970)226.0342  
 KANSAS CITY, MISSOURI  
 9001 STATE LINE RD., STE. 200 (816)361.0440

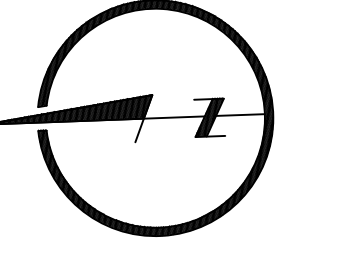

0 100 200

PRELIMINARY

NOT FOR CONSTRUCTION  
 MARK DANIEL MCGHEE

SUMMIT VIEW FARMS  
 BUFFER PLAN - NORTH  
 KANSAS CITY, JACKSON COUNTY, MISSOURI

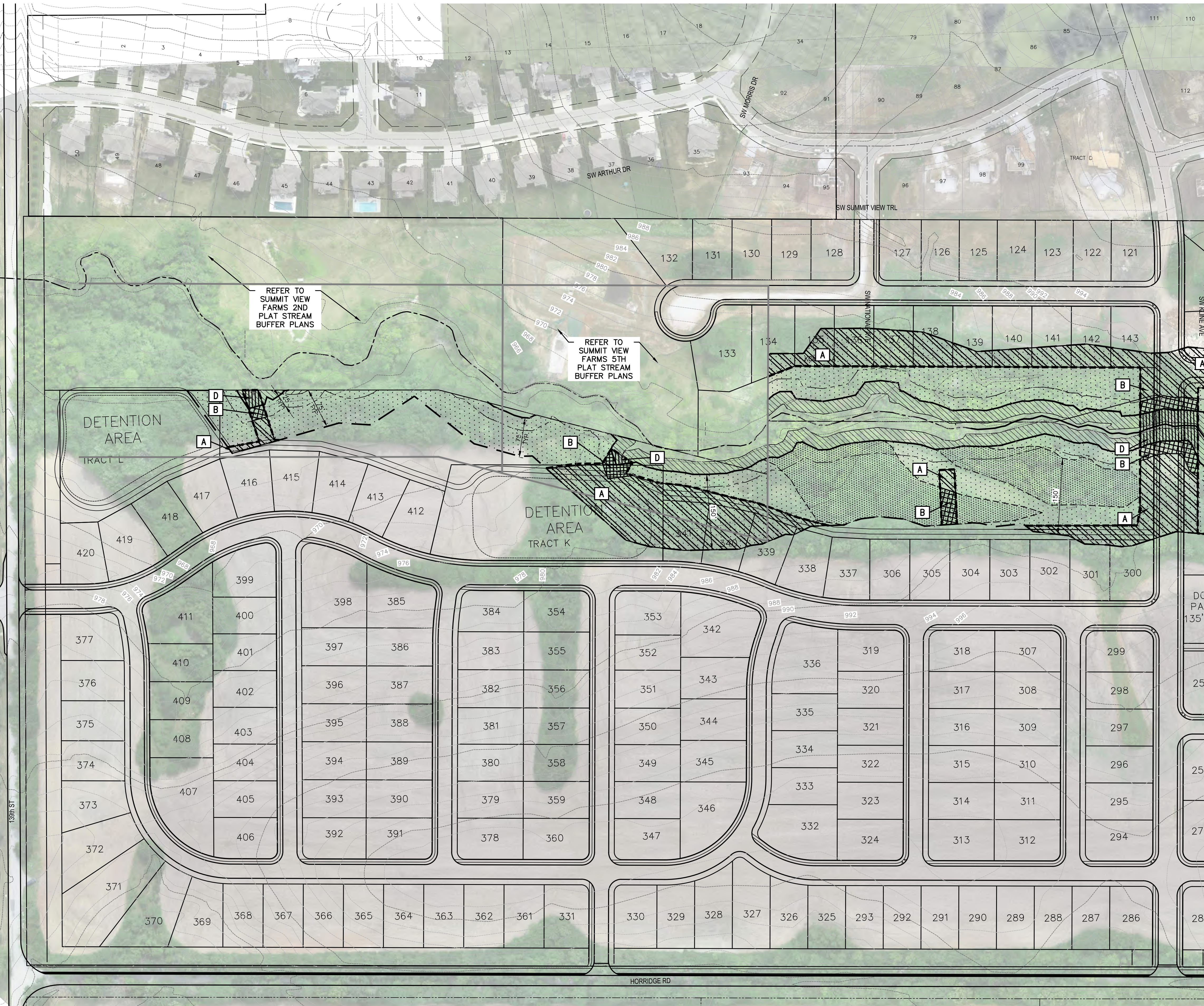

**LEGEND**

- EXISTING LOT LINES
- PROPOSED LOT LINES
- EXISTING IMPROVEMENTS
- PROPOSED IMPROVEMENTS
- FUTURE IMPROVEMENTS
- EXISTING MAJOR CONTOURS
- EXISTING MINOR CONTOURS
- PLAT BOUNDARY
- ROADWAY CENTERLINE
- STREAM CHANNEL
- ▨ STREAMSIDE ZONE
- FLOODPLAIN (NOT APPLICABLE)
- 25' CLEAR FROM MIDDLE ZONE EDGE
- ▨ OUTER ZONE
- ▨ MATURE VEGETATION/ SLOPES OVER 15% IN OUTER ZONE
- ▨ IMPACT AREA IN STREAMSIDE & MIDDLE ZONE
- ▨ IMPACT AREA IN OUTER ZONE (25' CLEAR, VEGETATED)
- ▨ IMPACT AREA IN OUTER ZONE
- ▨ DISTURBED AREA IN OUTER ZONE (40% MAX.)

**AREA CALCULATIONS**

TOTAL STREAMSIDE ZONE AREA	= 139,483	= 3.20 AC
TOTAL MIDDLE ZONE AREA	= 0	= 0.00 AC
TOTAL OUTER ZONE AREA	= 774,608	= 17.78 AC

MAX. 40% DISTURBED AREA IN OUTER ZONE VEGETATED (W/NO MITIGATION) = 7.11 AC

▨ DISTURBED AREA IN OUTER ZONE (BEYOND 25' CLEAR) = 3.47 AC

▨ IMPACT AREA IN OUTER ZONE (VEGETATED/WITHIN 25' CLEAR, 1.5:1 RATIO) = 2.49 AC

▨ DISTURBED AREA IN MIDDLE ZONE (4:1 RATIO) = 0.00 AC

▨ DISTURBED AREA IN STREAMSIDE ZONE (4:1 RATIO) = 0.81 AC

TOTAL DISTURBED AREA = 6.78 AC

TOTAL MITIGATION REQUIRED. = 0.00 AC\*

BREAKDOWN OF IMPACT AREAS				
IMPACT	RAW AREA (SF)	RAW AREA (AC)	MITIGATION MULTIPLIER	MITIGATION AREA (AC)
A	151,229	3.47	1	3.47
B	72,405	1.66	1.5	2.49
C	0	0.00	4	0.00
D	8,865	0.20	4	0.81
<b>TOTAL (AC)</b>				<b>6.78</b>

**NOTES:**

NO FEMA FLOODPLAIN EXISTS WITHIN THE SUMMIT VIEW FARMS PRELIMINARY PLAT.

\*MITIGATION WILL BE PERFORMED ON A PER PLAT BASIS. THIS PRELIMINARY PLAT SHOWS MITIGATION IS NOT REQUIRED. THIS IS SUBJECT TO CHANGE.

**811**  
 Know what's below.  
 Call before you dig.

**REVISIONS**  
 11/18/2022 - PER CITY COMMENTS

**DESIGNER / DRAFTER**  
 BDN  
 DATE  
 AUGUST, 2022  
 PROJECT NUMBER  
 0339042.01  
 BOOK AND PAGE

**SHEET**  
 9

C:\Engineering\2022\04\2022-04-17\0339042-01\0339042-01.dwg, 11/18/2022 8:11:14 AM, RYNEARSON, LAMP

SUMMIT VIEW FARMS  
DEVELOPMENT PLAN AND PRELIMINARY PLAT  
PART OF NW ¼ AND SW 1/4, SECTION 26, TOWNSHIP 47 NORTH,  
RANGE 32 WEST  
KANSAS CITY, JACKSON COUNTY, MISSOURI

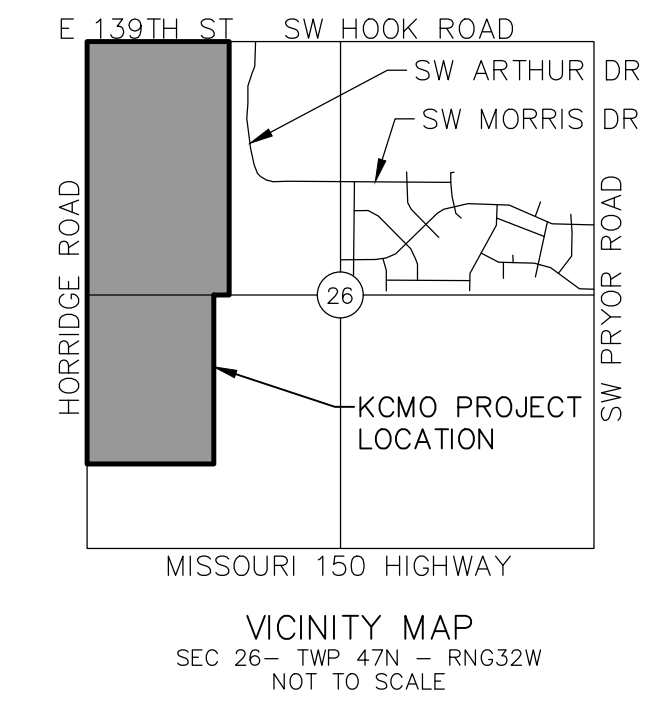

**LAMP RYNEARSON**  
LAMPRYNEARSON.COM  
OMAHA, NEBRASKA  
14710 W. DODGE RD., STE. 100 (402)996.2498  
FORT COLLINS, COLORADO  
4715 INNOVATION DR., STE. 100 (970)226.0342  
KANSAS CITY, MISSOURI  
9001 STATE LINE RD., STE. 200 (816)361.0440

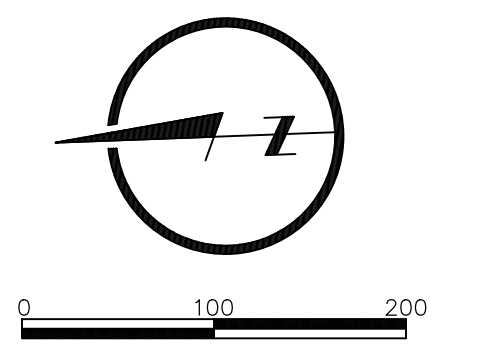

PRELIMINARY

NOT FOR CONSTRUCTION  
MARK DANIEL MCGHEE

SUMMIT VIEW FARMS  
BUFFER PLAN - SOUTH  
KANSAS CITY, JACKSON COUNTY, MISSOURI

**811**  
Know what's below.  
Call before you dig.

REVISIONS

NO.	DATE	DESCRIPTION
11/18/2022	11/18/2022	- PER CITY COMMENTS

DESIGNER / DRAFTER  
BDN  
DATE  
AUGUST, 2022  
PROJECT NUMBER  
0319042.01  
BOOK AND PAGE

SHEET  
10

**LEGEND**

- EXISTING LOT LINES
- PROPOSED LOT LINES
- EXISTING IMPROVEMENTS
- PROPOSED IMPROVEMENTS
- ..... FUTURE IMPROVEMENTS
- EXISTING MAJOR CONTOURS
- EXISTING MINOR CONTOURS
- PLAT BOUNDARY
- ROADWAY CENTERLINE
- STREAM CHANNEL
- ▨ STREAMSIDE ZONE
- ..... FLOODPLAIN (NOT APPLICABLE)
- 25' CLEAR FROM MIDDLE ZONE EDGE
- ▨ OUTER ZONE
- ▨ MATURE VEGETATION/ SLOPES OVER 15% IN OUTER ZONE
- ▨ IMPACT AREA IN STREAMSIDE & MIDDLE ZONE
- ▨ IMPACT AREA IN OUTER ZONE (25' CLEAR, VEGETATED)
- ▨ IMPACT AREA IN OUTER ZONE
- ▨ DISTURBED AREA IN OUTER ZONE (40% MAX.)

**AREA CALCULATIONS**

TOTAL STREAMSIDE ZONE AREA	= 139,483	= 3.20 AC
TOTAL MIDDLE ZONE AREA	= 0	= 0.00 AC
TOTAL OUTER ZONE AREA	= 774,608	= 17.78 AC

MAX. 40% DISTURBED AREA IN OUTER ZONE VEGETATED (W/NO MITIGATION) = 7.11 AC

▨ DISTURBED AREA IN OUTER ZONE (BEYOND 25' CLEAR) = 3.47 AC

▨ IMPACT AREA IN OUTER ZONE (VEGETATED/WITHIN 25' CLEAR, 1.5:1 RATIO) = 2.49 AC

▨ DISTURBED AREA IN MIDDLE ZONE (4:1 RATIO) = 0.00 AC

▨ DISTURBED AREA IN STREAMSIDE ZONE (4:1 RATIO) = 0.81 AC

TOTAL DISTURBED AREA = 6.78 AC

TOTAL MITIGATION REQUIRED. = 0.00 AC\*

**BREAKDOWN OF IMPACT AREAS**

IMPACT	RAW AREA (SF)	RAW AREA (AC)	MITIGATION MULTIPLIER	MITIGATION AREA (AC)
A	151,229	3.47	1	3.47
B	72,405	1.66	1.5	2.49
C	0	0.00	4	0.00
D	8,865	0.20	4	0.81
TOTAL (AC)				6.78

NOTES:

NO FEMA FLOODPLAIN EXISTS WITHIN THE SUMMIT VIEW FARMS PRELIMINARY PLAT.

\*MITIGATION WILL BE PERFORMED ON A PER PLAT BASIS. THIS PRELIMINARY PLAT SHOWS MITIGATION IS NOT REQUIRED. THIS IS SUBJECT TO CHANGE.

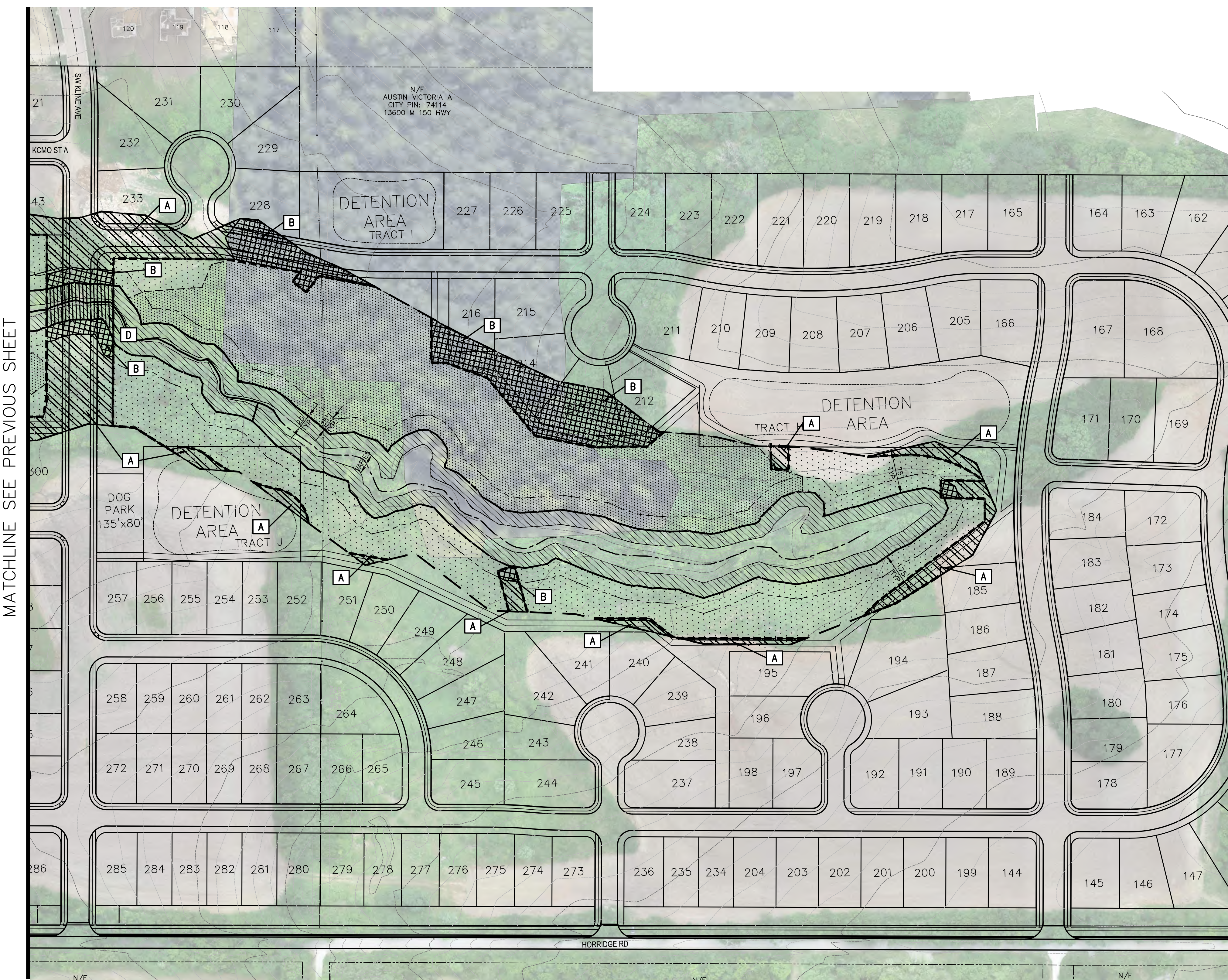

MATCHLINE SEE PREVIOUS SHEET

C:\Engineering\2022\0319042\_01\FD\KCMO\_Civil\SummitViewFarms\0319042\_01\_Buffer\_2022.dwg, 11/18/2022 8:17:40 PM, MARK DANIEL MCGHEE, LAMP RYNEARSON

SUMMIT VIEW FARMS

ZONING MAP AMENDMENT

PART OF NW 1/4, AND SW 1/4 SECTION 26, TOWNSHIP 47 NORTH, RANGE 32 WEST

KANSAS CITY, JACKSON COUNTY, MISSOURI

**LEGEND**

	LOT LINE/ R/W LINE
	PARCEL FOR REZONING
	PARCEL WITHIN 300-FEET OF SUBJECT PROPERTY. REFER TO CITY'S NOTIFICATION LIST.
	PROPOSED R-7.5 ZONING

**LAMP RYNEARSON**

LAMPRYNEARSON.COM

OMAHA, NEBRASKA  
 14710 W. DODGE RD., STE. 100 (402)496.2498  
 FORT COLLINS, COLORADO  
 4715 INNOVATION DR., STE. 100 (970)226.0342  
 KANSAS CITY, MISSOURI  
 9001 STATE LINE RD., STE. 200 (816)361.0440

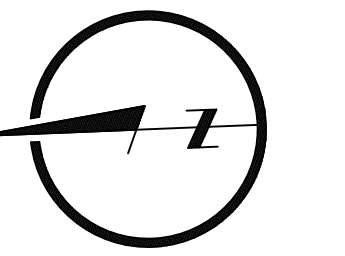

PRELIMINARY

NOT RELEASED FOR CONSTRUCTION

ZONING MAP AMENDMENT

KANSAS CITY, JACKSON COUNTY, MISSOURI

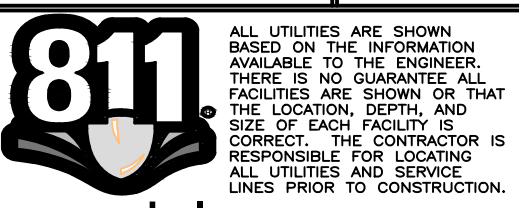

REVISIONS

11/18/2022 - PER CITY COMMENTS

DESIGNER / DRAFTER  
BRANCE NEAL

DATE  
AUGUST, 2022

PROJECT NUMBER  
0319042

BOOK AND PAGE

MISSOURI AUTHORIZATION NUMBER  
LAMP RYNEARSON LS-2019043127

ENGINEER / SURVEYOR  
LAMP RYNEARSON, INC.  
9001 STATE LINE ROAD, SUITE 200  
KANSAS CITY, MO 64114  
DAN MCGHEE  
(816) 361-0440

DEVELOPER  
SUMMIT VIEW FARMS DEVELOPMENT GROUP, LLC  
P.O. BOX 291  
LEE'S SUMMIT, MO 64063  
(816) 838-0552

SHEET  
11

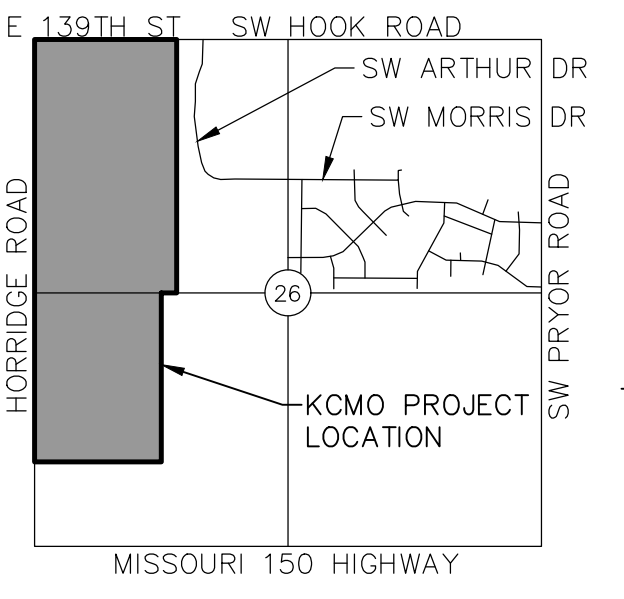

VICINITY MAP  
 SEC 26 - TWP 47N - RNG32W  
 NOT TO SCALE

-- SUMMIT VIEW FARMS PRELIMINARY PLAT LEGAL DESCRIPTION --

All that part of the Northwest and Southwest Quarters of Section 26, Township 47 North, Range 32 West, situate in the City of Kansas City, Jackson County, Missouri, being described as follows:

Beginning at the Northwest corner of said Section 26; thence South 88°06'19" East, along the North line of said Section 26, a distance of 1,504.55 feet to the intersection with the North line of said Section 26 and the Northerly prolongation of the West line of SUMMIT VIEW FARMS AMENDED 1<sup>ST</sup> PLAT, a subdivision of record filed with the Jackson County, Missouri Register of Deeds as Instrument No. 2017E0048627, said line also being the city limit line between Kansas City, Missouri and Lee's Summit, Missouri; thence South 2°22'18" West, along the West line of said SUMMIT VIEW FARMS AMENDED 1<sup>ST</sup> PLAT and its Northerly prolongation and also along the West line of SUMMIT VIEW FARMS 4<sup>TH</sup> PLAT, a subdivision of record filed with said Register of Deeds as Instrument No. 2022E0006745, a distance of 1,624.62 feet; thence South 2°21'56" West, continuing along the West line of said SUMMIT VIEW FARMS 4<sup>TH</sup> PLAT, a distance of 1,033.59 feet to the Southwest plat corner thereof, said point also being on the North line of the Southwest Quarter of said Section 26; thence North 87°59'47" West, along the North line of the Southwest Quarter of said Section 26, a distance of 179.92 feet to a point on the East line of the West Half thereof; thence South 2°23'27" West, along the East line of the West Half of the Southwest Quarter of said Section 26, a distance of 1,766.36 feet to the Northeast corner of the plat of LEE'S SUMMIT ELEMENTARY SCHOOL NO. 17, a subdivision of record filed with said Register of Deeds as Instrument No. 2007E0094456; thence North 88°09'04" West, along the North line of said LEE'S SUMMIT ELEMENTARY SCHOOL NO. 17 and its Westerly prolongation, a distance of 1,318.91 feet to a point on the West line of the Southwest Quarter of said Section 26; thence North 2°18'40" East, along the West line of the Southwest Quarter of said Section 26, a distance of 1,769.90 feet to the Southwest corner of the Northwest Quarter of said Section 26; thence North 2°17'56" East, along the West line of the Northwest Quarter of said Section 26, a distance of 2,655.32 feet to the Point of Beginning.

Containing 6,326,781 square feet or 145.24 acres, more or less.  
 The bearings in this description are based on the Missouri Coordinate System of 1983, West Zone, NAD83.

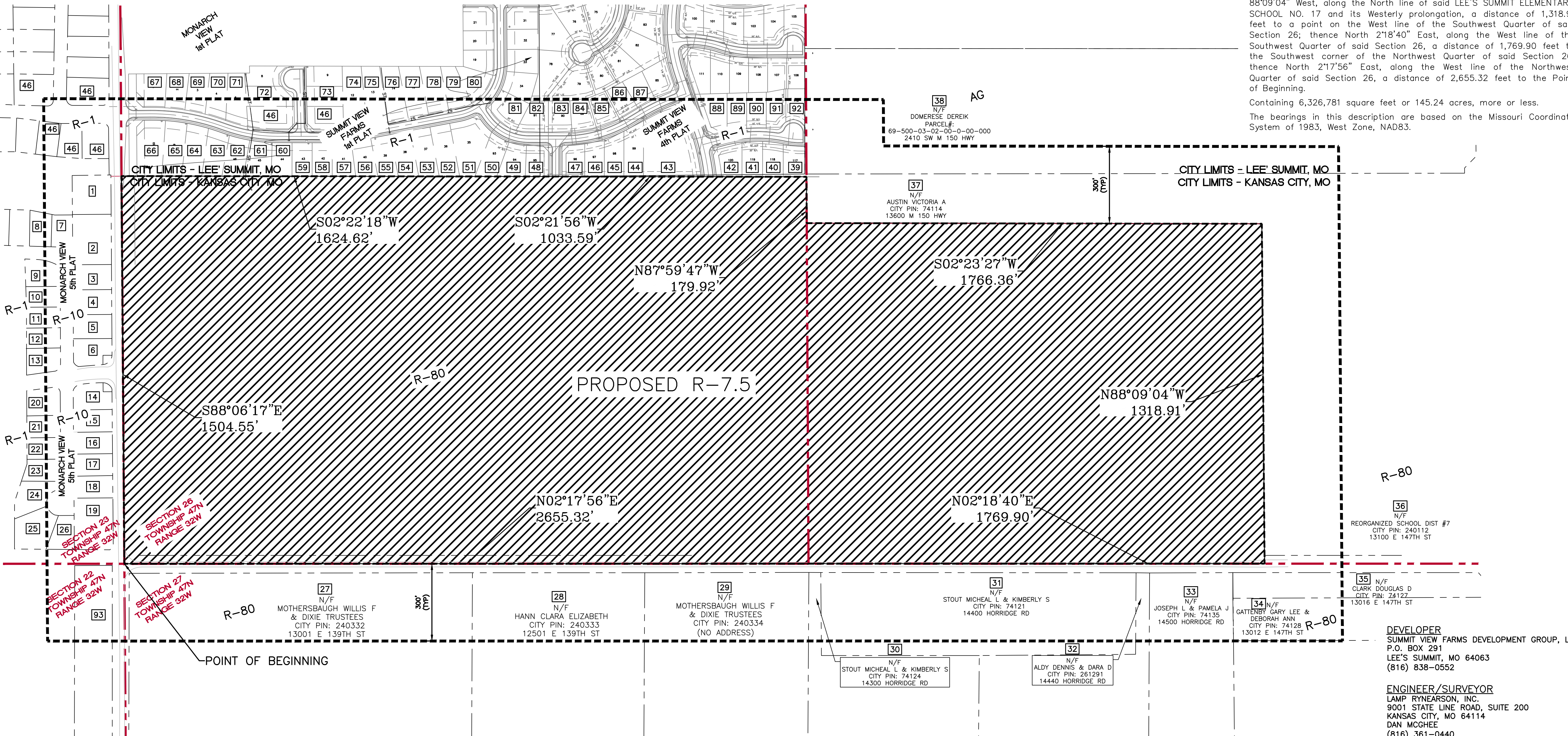

U:\p\l\0319042\0319042\_0300\_0400\0319042\_0300\_0400\MISSOURI\_ZONING\_MAP\_PRR00004.DWG, 11/18/2022 9:16:11 PM, BRANCE NEAL, LAMP RYNEARSON

# SUMMIT VIEW FARMS

## STREET NAME PLAN

PART OF NW ¼, AND SW ¼ SECTION 26, TOWNSHIP 47 NORTH,  
RANGE 32 WEST

KANSAS CITY, JACKSON COUNTY, MISSOURI

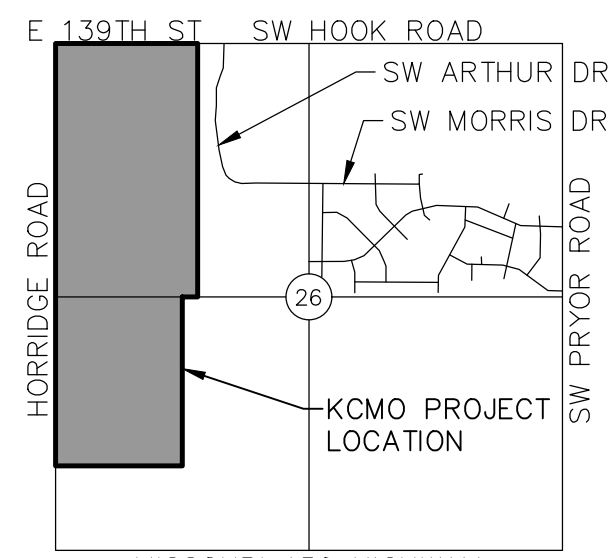

MISSOURI 150 HIGHWAY

VICINITY MAP  
SEC 26 - TWP 47N - RNG 32W  
NOT TO SCALE

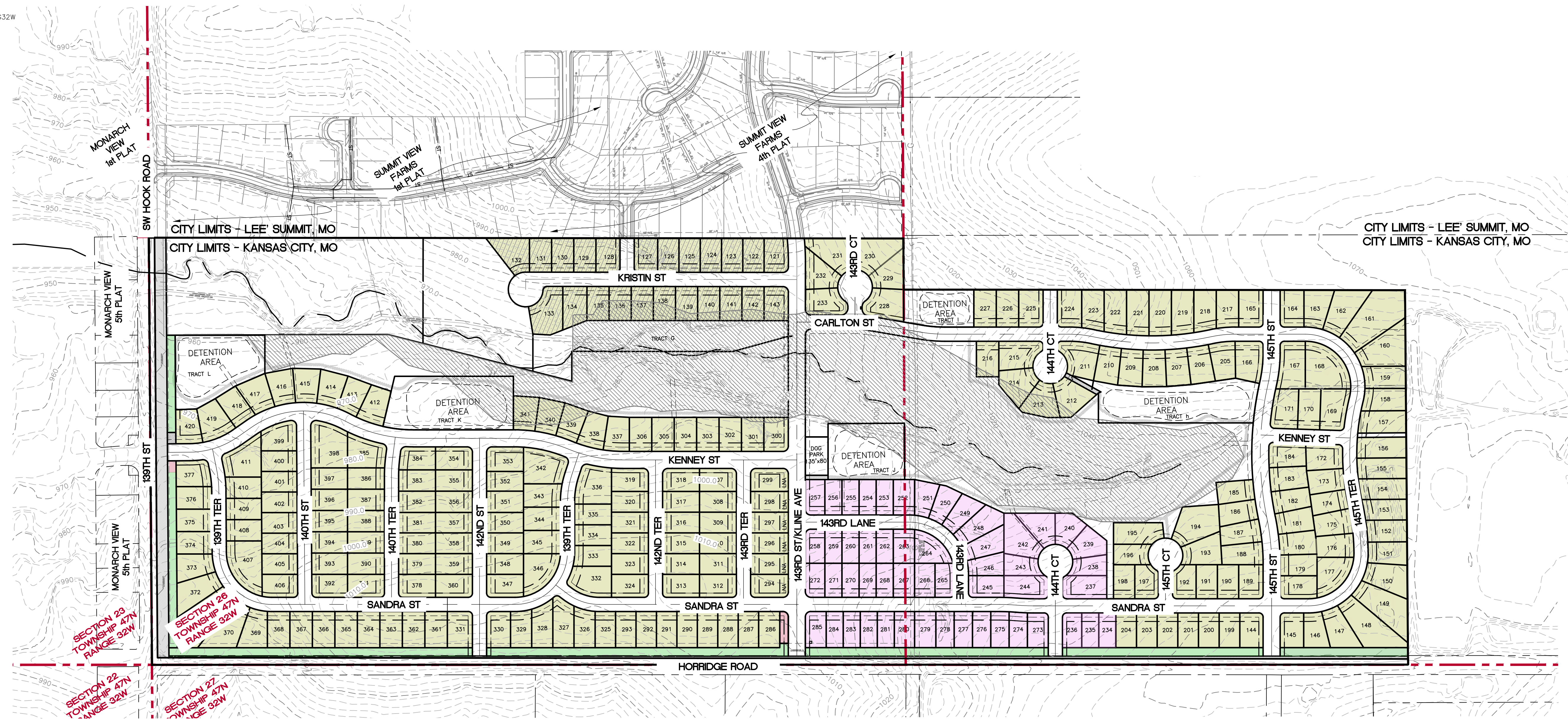

SECTION 23  
TOWNSHIP 47N  
RANGE 32W

SECTION 26  
TOWNSHIP 47N  
RANGE 32W

SECTION 27  
TOWNSHIP 47N  
RANGE 32W

**LAMP  
RYNEARSON**

LAMPRYNEARSON.COM

OMAHA, NEBRASKA  
14710 W. DODGE RD., STE. 100 (402)496.2498  
FORT COLLINS, COLORADO  
4715 INNOVATION DR., STE. 100 (970)226.0342  
KANSAS CITY, MISSOURI  
9001 STATE LINE RD., STE. 200 (816)361.0440

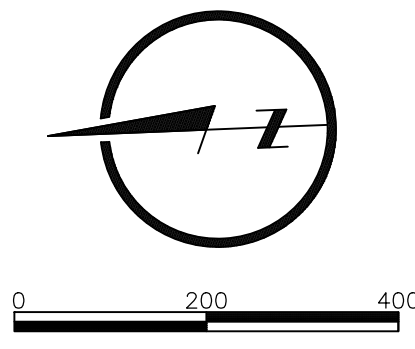

PRELIMINARY

NOT RELEASED FOR CONSTRUCTION

STREET NAME PLAN

KANSAS CITY, JACKSON COUNTY, MISSOURI



Know what's below.  
Call before you dig.

REVISIONS

11/18/2022	- PER CITY COMMENTS

DESIGNER / DRAFTER	BRANCE NEAL
DATE	JULY, 2022
PROJECT NUMBER	0319042
BOOK AND PAGE	BOOK AND PAGE

SHEET	12
-------	----

DEVELOPER  
SUMMIT VIEW FARMS DEVELOPMENT GROUP, LLC  
P.O. BOX 291  
LEE'S SUMMIT, MO 64063  
(816) 838-0552

ENGINEER/SURVEYOR  
LAMP RYNEARSON, INC.  
9001 STATE LINE ROAD, SUITE 200  
KANSAS CITY, MO 64114  
DAN MCGHEE  
(816) 361-0440

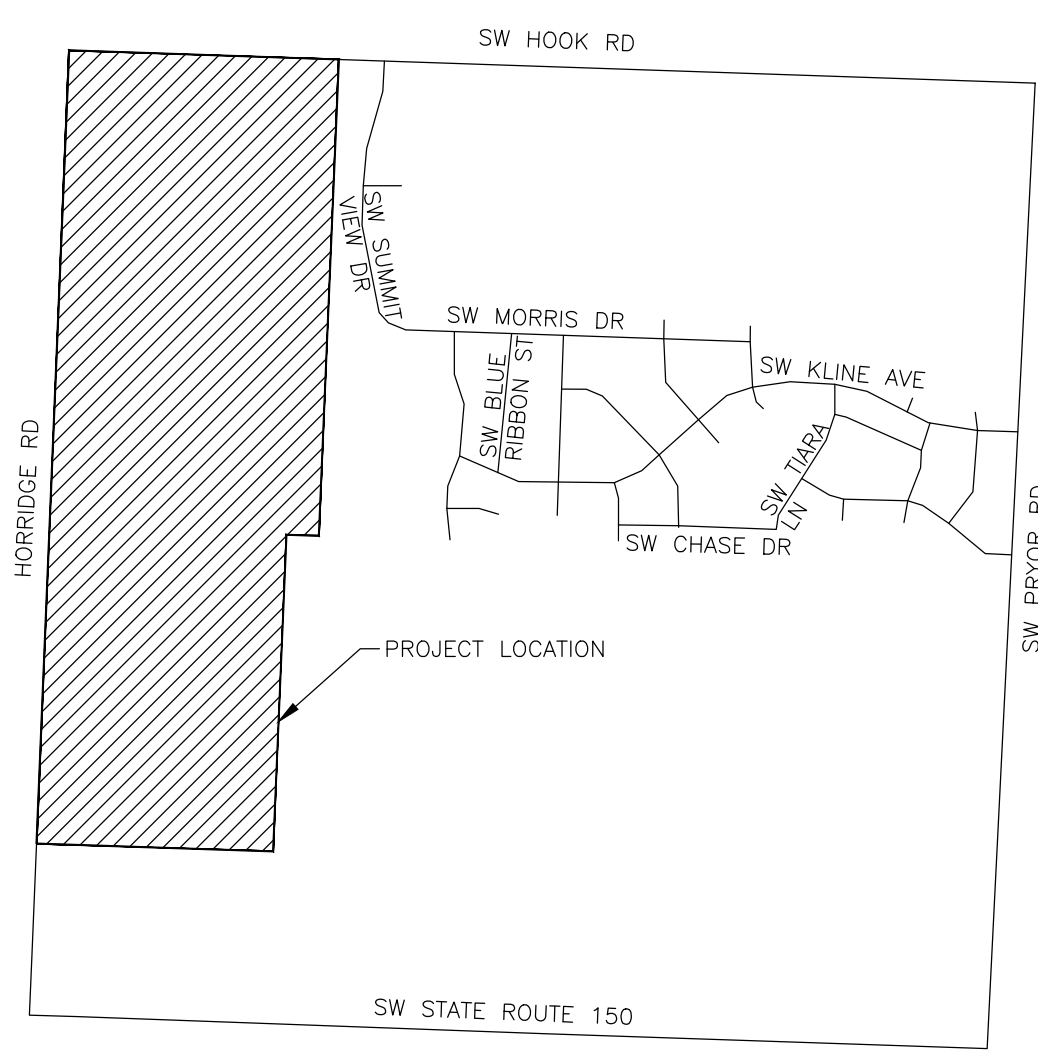

U:\Open\10319042\_2022\_1040\_00000001\SUMMITVIEW\_FARMS\_000003\0319042 - Prelim.dwg, 11/18/2022, 2:18:38 PM, BRANCE, NEAL, LAMP RYNEARSON



# CITY PLANNING & DEVELOPMENT

---

## Public Meeting Summary Form

Project Case #

Meeting Date:

Meeting Location:

Meeting Time (include start and end time):

Additional Comments (optional):

# Meeting Sign-In Sheet

Project Name and Address

---

---

Name	Address	Phone	Email
Matt Stout	14300 Horridge		
Dennis Daldy	Horridge		



## Welcome to Summit View Farms



**Summit View Farms currently has a potential of 426 lots planned with 52 maintenance-free Villas on 190 acres.... and over 20 acres of greenspace!**

Summit View Farms is very unique because it contains 2 separate addresses while having the same Lee's Summit Schools. All lots will have Summit Pointe Elementary, Summit Lakes Middle School and Lee's Summit West High School.

- \* 47 acres have Lee's Summit address and Lee's Summit Schools
  - 120 lots are planned within the 47 acres.
- \* 143 Acres have Kansas City Address, Lee's Summit Schools

As with any future plat, these numbers are subject to change

Phase 2 is open.

Phase 3 the Great Amenities are projected to go in.

Located at the center of the subdivision with child safety and beauty in mind

- A Community Pool with water features and plenty of space for pool chairs.
- Party / Barbecue Area with 2 covered Pergolas
- Pocket Park
- Playground

A FUTURE PHASE will include a Pet Park



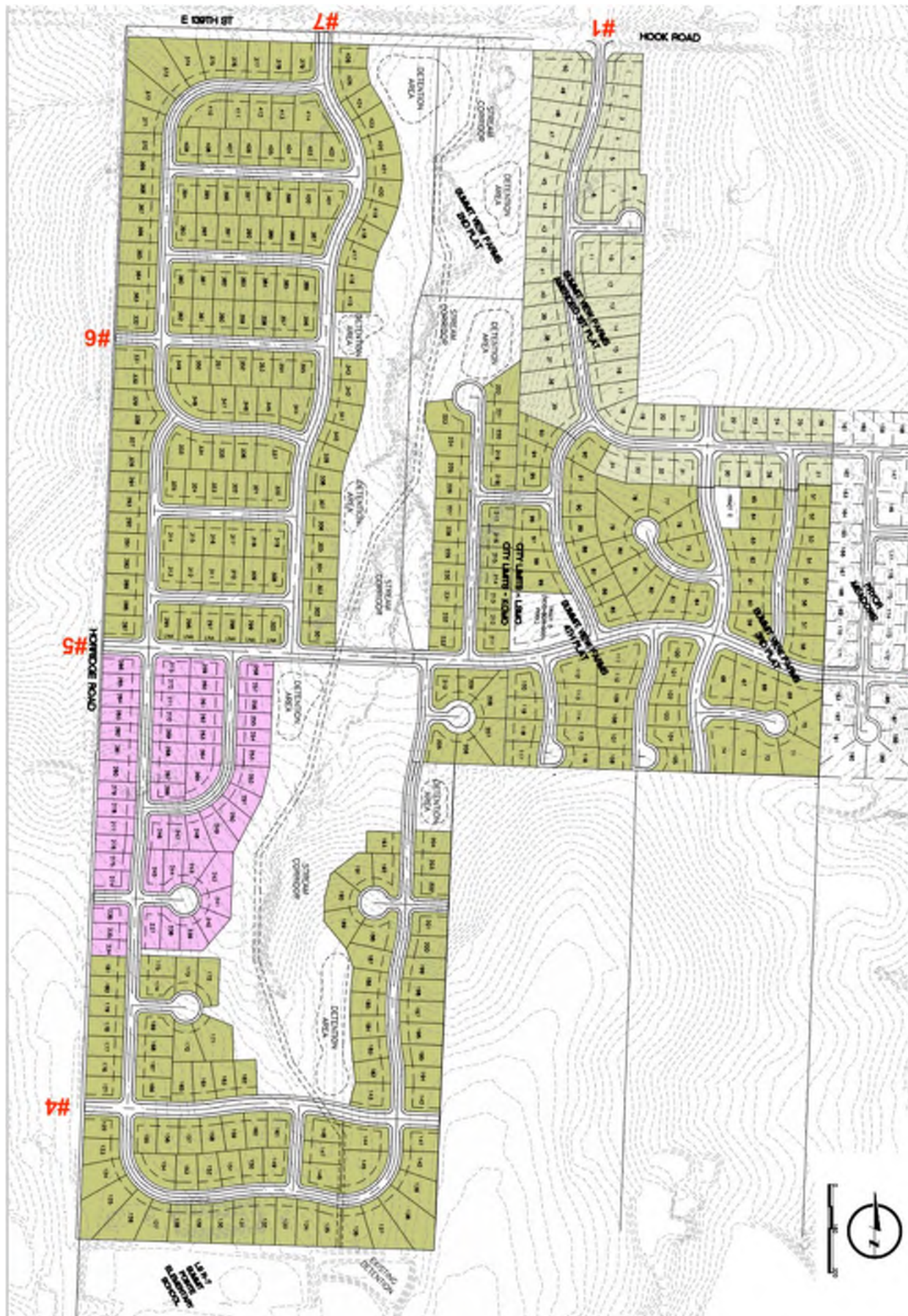

#1  
HOOK ROAD

#2

#3  
Collector Street



#4

#5

#6

#7



# SUMMIT VIEW FARM'S



PHASE I	PHASE III
PHASE II	PHASE IV KANSAS CITY, MO